

FAMSI © 2007: Patricia A. Urban

Rural Production in Northwest Honduras: The 2004 Season of the Lower Cacaupala Valley Archaeological Project

With contributions by: Edward M. Schortman, Anthropology Department, Kenyon College



Research Year: 2004

Culture: Maya

Chronology: Middle Pre-Classic to Early Post Classic

Location: Lower Cacaupala Valley, Northwest Honduras

Sites: El Coyote, Las Canoas

Table of Contents

[Introduction](#)

[Methods](#)

[Excavations](#)

[Site 607](#)

[Site 598](#)

[Site 120](#)

[Site 161](#)

[Site 162](#)

[Craft Production](#)

[Ceramic Production](#)

[Obsidian Production](#)

[Copper Processing](#)

[Trade](#)

[Summary](#)

[Preclassic and Early Classic](#)

[Late Classic](#)

[Early Postclassic](#)

[Acknowledgements](#)
[List of Figures](#)
[Sources Cited](#)

Submitted 08/23/2006 by:
Patricia A. Urban
Anthropology Department
Kenyon College, Gambier, OH
urban@kenyon.edu

Introduction

The Late Classic (A.D. 600-800), Terminal Classic (A.D. 800-1000), and Early Postclassic (A.D. 1000-1300) mark major shifts in the political economies of Southeast Mesoamerica (the adjoining portions of eastern Guatemala, western Honduras, and El Salvador; [Figure 1](#)). Late Classic magnates centralized power and engaged in long-distance exchanges with their elite peers to secure symbols of rulership. From the Terminal Classic through Early Postclassic many of the realms bound together in these interaction networks began to disintegrate while intersocietal transactions dwindled. By the early 14th century, only the ruins of grand political dreams remained throughout much of the area (Hasemann *et al.* 1978; Hendon 2000; Joyce 1988, 1991; Nakamura *et al.* 1991; Robinson 1987; Schortman 1993; Schortman *et al.* 1986; Urban and Schortman 1988; Sharer 1990; Sheptak 1987; Urban and Schortman 1988; Webster *et al.* 2000).

Though this general picture is clear enough, we know little about how power contests played out on the local level and the implications of these competitions for broader scale developments. There is also the creeping suspicion that heterogeneous political, economic, and cultural forms and processes among polities are obscured within seemingly uniform regional trends. The investigations sponsored by FAMSI in 2004 within the adjoining lower Cacaupala and middle Chamelecon drainages of northwest Honduras focused on these issues. Specifically, excavations at five rural hamlets in these narrow valleys (see [Figure 2](#) for site locations) were designed to shed light on what roles, if any, craft production played in advancing elite domination strategies and thwarting those grand designs. Our earlier research in the nearby Naco valley suggested that Late Classic processes of political centralization were underwritten, in part, by paramount monopolies over fashioning and distributing a suite of generally needed goods. The majority of people, therefore, became clients of the monopolists, constrained to obey the latter or lose access to essential commodities (Urban *et al.* 1996; Schortman and Urban 1994; see also Brumfiel and Earle 1987; Ekholm 1972; Hayden 1995, 1998). Ongoing research, however, at the sizable lower Cacaupala center of El Coyote ca. 9 km southwest of Naco indicated that the power of its Late Classic rulers was not founded on control over craft production. In fact, El Coyote's residents seemed to be consumers, not manufacturers, of basic goods. The situation seemingly changed during the Early Postclassic (A.D. 1000-1300) when Naco's Late Classic capital, La Sierra, was abandoned: craft production of all sorts in the valley ended, but El Coyote now became the center of fairly large-scale chert tool and, possibly, copper processing industries. Such contrasts strongly suggest the existence, side-by-side, of two very different political economies, each with its own distinctive trajectory. Different paths may have led to the same ends.

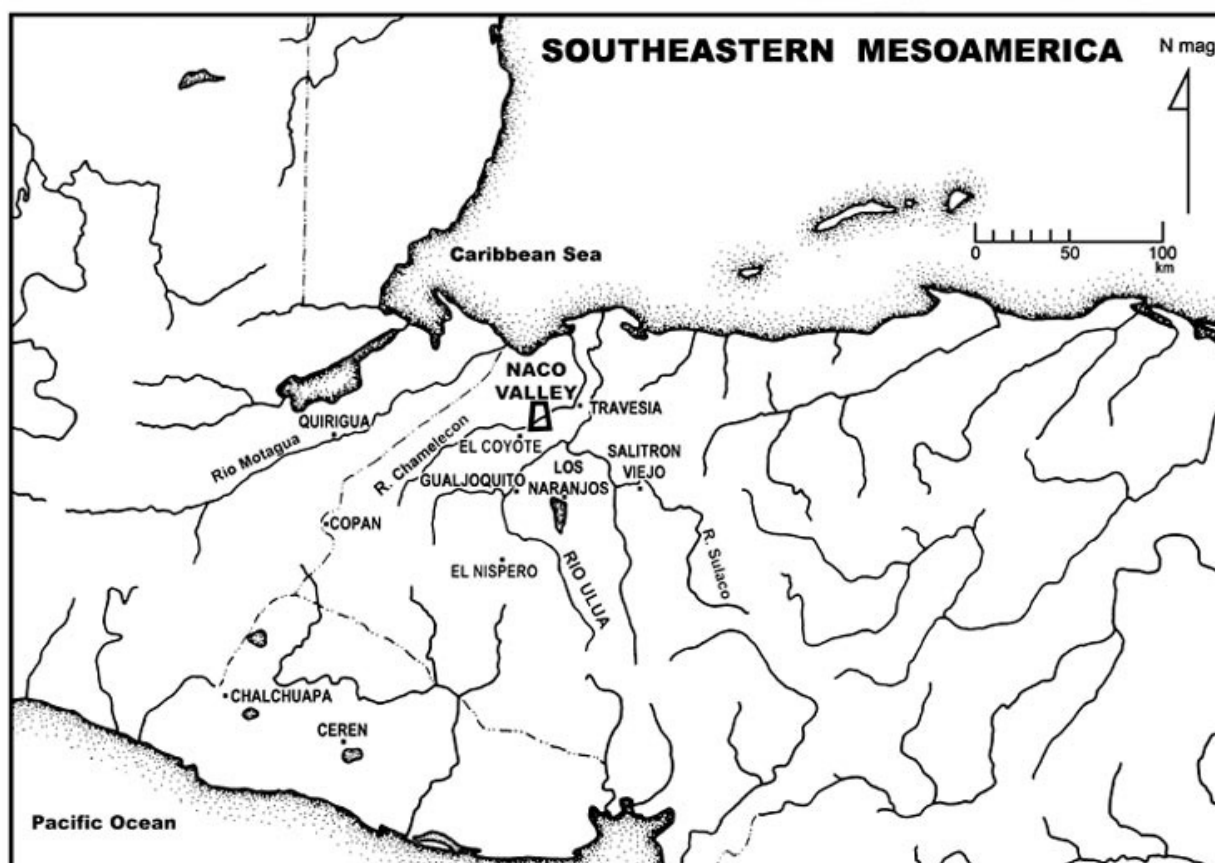

Figure 1. Map of Southeastern Mesoamerica.

Learning more about these processes, and why two adjacent polities had such different histories, required expanding research from ancient capitals to their rural hinterlands. It was only in this way that we could reconstruct patterns of production, consumption, and distribution for entire realms (Costin 1991; Pool 1992; Tosi 1984). This information is crucial to understanding how rural and urban populations, elites and commoners, together fashioned the evolving political and economic structures whose outlines we were beginning to perceive. Excavations conducted in 70 (15%) of Naco's 463 rural settlements were completed by 1996, but only five comparable sites, out of a total of 73 known examples (6.8%), had been investigated near Las Canoas (16 sites) and El Coyote (57 sites). The 2004 season was designed, in part, to redress this imbalance.

The five locales chosen for study in 2004, Sites 120, 161, 162, 598, and 607, are in a line extending 4 km west/southwest along the Rio Chamelecon from the site of Las Canoas (Site 202) and 6.5 km south from the Rio Cacaupala's junction with the Chamelecon to El Coyote (Figure 2). Las Canoas is a moderately large center containing 120 structures clustered around a central plaza bounded by five monumental platforms (structures at least 1.5 m high; Figure 3). Excavations conducted here in 2002 by M. Stockett suggested that Las Canoas was founded as an outlier of La Sierra early in the Late Classic. Its residents apparently mediated contacts between the Late Classic La Sierra realm and those polities lying to the west. Further, the site was a major center of ceramic production throughout the Late Classic, possibly extending into the Terminal Classic (A.D. 800-950) after the focal point of

public administration and ritual, the central plaza, had fallen into disuse. Additional excavations at Las Canoas in 2004 (not funded by FAMSI) were designed to test this model.

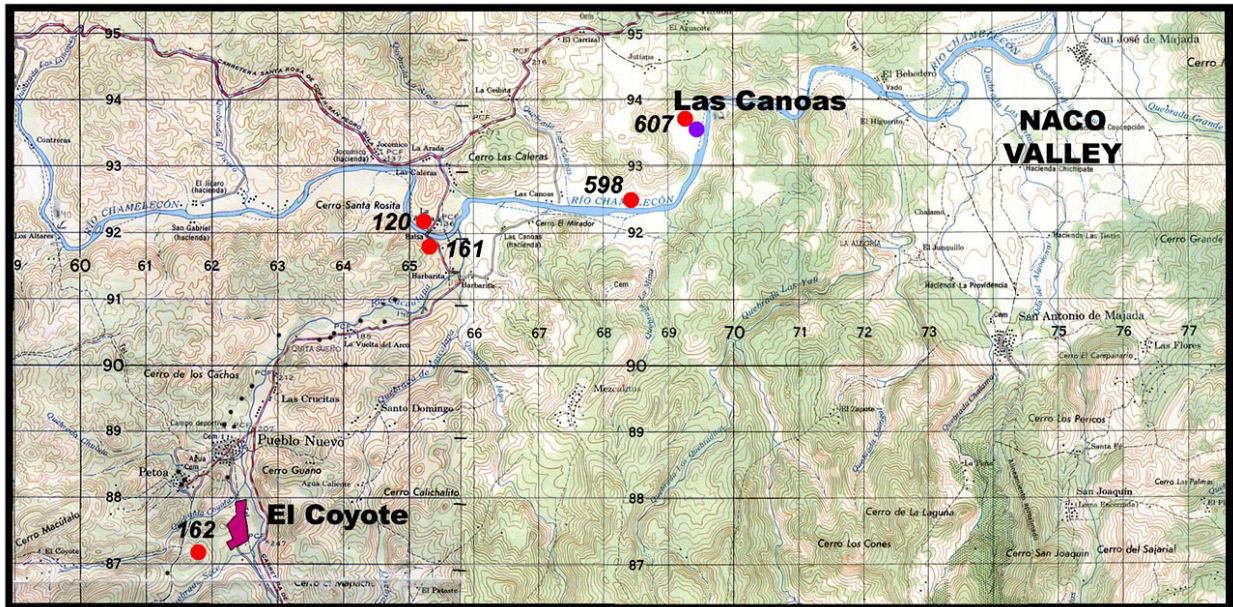

Figure 2. Sites mentioned in the text.

By studying five rural settlements dispersed between Las Canoas and El Coyote, we hoped to assess how patterns of production, consumption, and distribution shifted between areas that were likely part of the La Sierra political economy, Sites 607 and 598 near Las Canoas in the Chamelecon valley, and those outside its sphere, Sites 120, 161, and 162 in the lower Cacaupala valley. As noted above, we were especially interested in political, economic, and cultural developments dating to the Late Classic through Early Postclassic but avidly collected data pertaining to other periods as well.

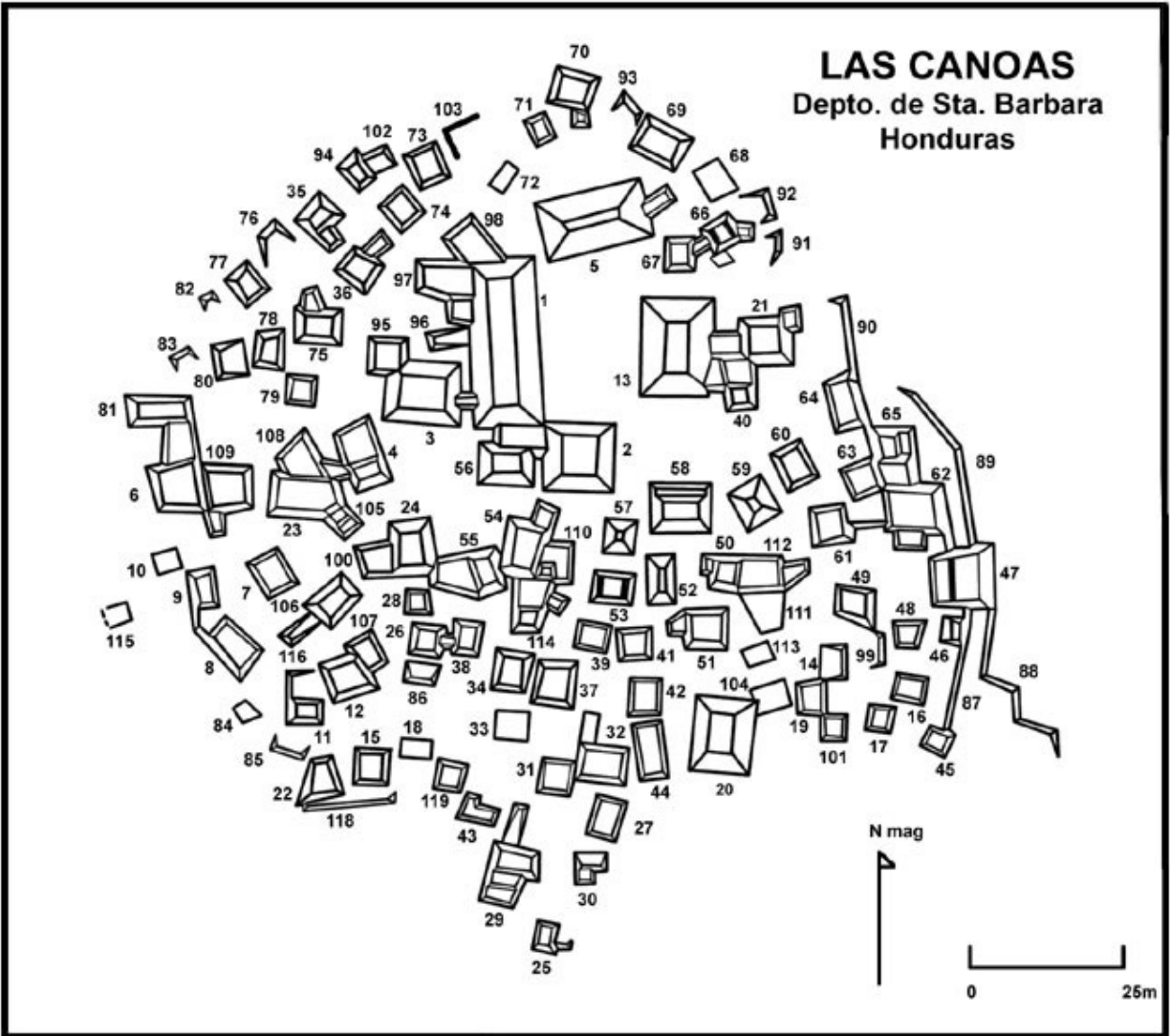

Figure 3. Site PVN 202, Las Canoas Site Map (PVN: Proyecto Valle de Naco).

Methods

At each site, every effort was made to select structures for excavation that spanned the full range of size and morphological variation seen on the ground surface at the settlement. Digging began with a trench set on each platform's axis, usually running from the patio-facing side of the edifice across to its presumed back. Architecture identified in this, the portion of the building where construction units were likely best preserved, was then followed laterally to the extent that time allowed. Our goal was to expose as much of every investigated structure as possible to reconstruct its basal dimensions and identify architectural patterns and artifact associations crucial to inferring the activities that were performed on and around the building. A portion of the axial trench was pursued to sterile to reconstruct the sequence of occupation at a site. Probes into construction were limited by Honduran law which restricts the extent to which standing architecture can be disturbed in excavations.

Recovered artifacts were washed and processed at the project lab in the town of Pueblo Nuevo, Santa Bárbara. Processing involves sorting finds into general categories, such as incense burners and figurines, counting the numbers of items within each taxon, and entering those figures on forms for each collection unit, or "lot." A sample of washed and processed pottery sherds was then subjected to more intensive analysis, while artifacts were cataloged. The choice of items for further study was determined by the importance of their contexts: e.g., objects from sealed deposits had a higher priority than those from construction fill.

Pottery sherds were classified according to the type-variety-mode system to date deposits and infer activities based on the distribution of such functionally sensitive attributes as vessel form. Figurines, whistles, ocarinas, incense burners, grinding stones, potstands, worked and used sherds, and other distinctive artifacts were drawn and described on catalog forms; particularly informative pieces were also photographed. Obsidian tools were analyzed by W. McFarlane, his efforts focusing on identifying features relevant to describing their sources, modes of manufacture, and how they were used. All recovered artifacts were washed and processed. Fully 31,538 sherds and 1,874 obsidian implements and pieces of debris were analyzed while 958 items were cataloged. Additional studies were carried out in the summer of 2005, all of which support the conclusions reported herein based on 2004 excavation and analysis.

Excavations

Site 607

Site 607 is located about 500 m northwest of Las Canoas on the same river terrace as that center. It consists of five buildings: Strs. 2–4 define a patio on the settlement's western margin while Strs. 1 and 5 are scattered to the east ([Figure 4](#)). Four of these structures were excavated this season. Fully 146 m² were uncovered in the course of these investigations directed by D. Aguilar, L.A. Ellison, A. Novotny, and C. Webber.

Structure 607-1 is the easternmost building in the settlement, lying ca. 45 m east of the settlement's principal plaza. The structure consists of a stone-faced platform standing 0.3 m high, measuring 4.1 × 4.12 m and oriented 187 degrees (see [Figure 5](#) for the Site 607 excavation plan). The summit supports a single earthen-floored room measuring ca. 2.5 × 2.85 m ([Figure 6](#)). Running down the approximate center of this enclosure is a 0.1 m high stone wall that is 0.9 m across (east-west) and runs north at this width for 2.25 m from the summit's south margin; this construction is indented 0.4 m on the north, narrowing to 0.5 m over its northernmost 0.6 m. The significance of this wall is uncertain; its considerable width and length suggest that it may have been a bench. A low stone step set against the platform's west side near the northwest corner provided access to the summit.

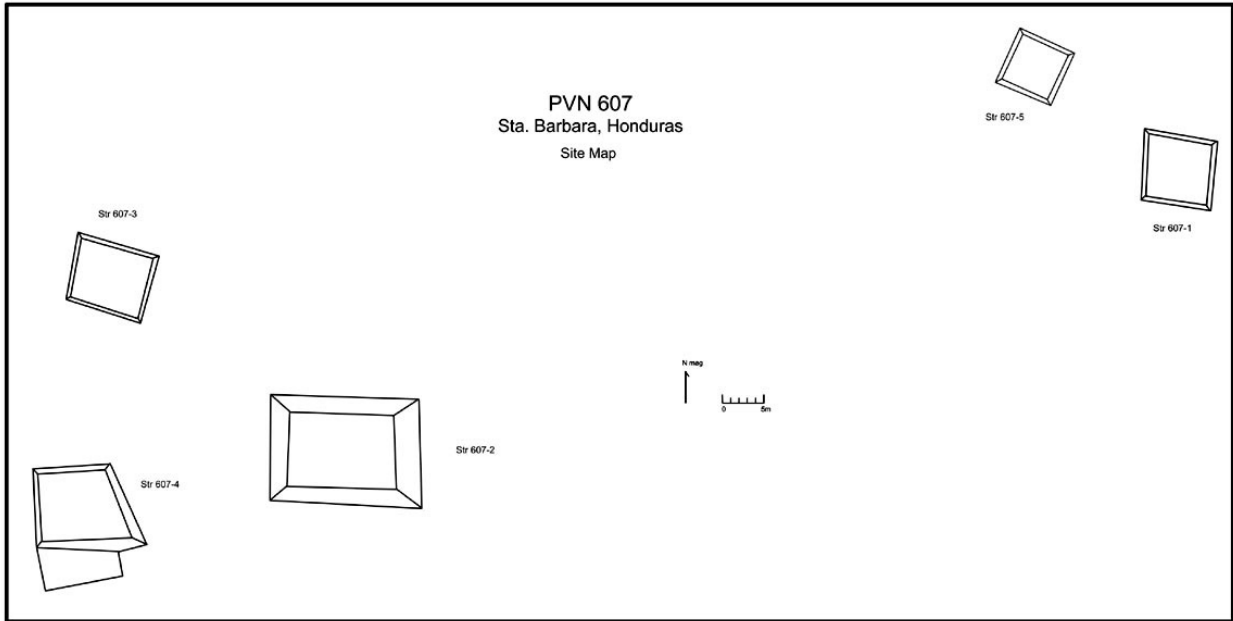

Figure 4. Site PVN 607 Site Map.

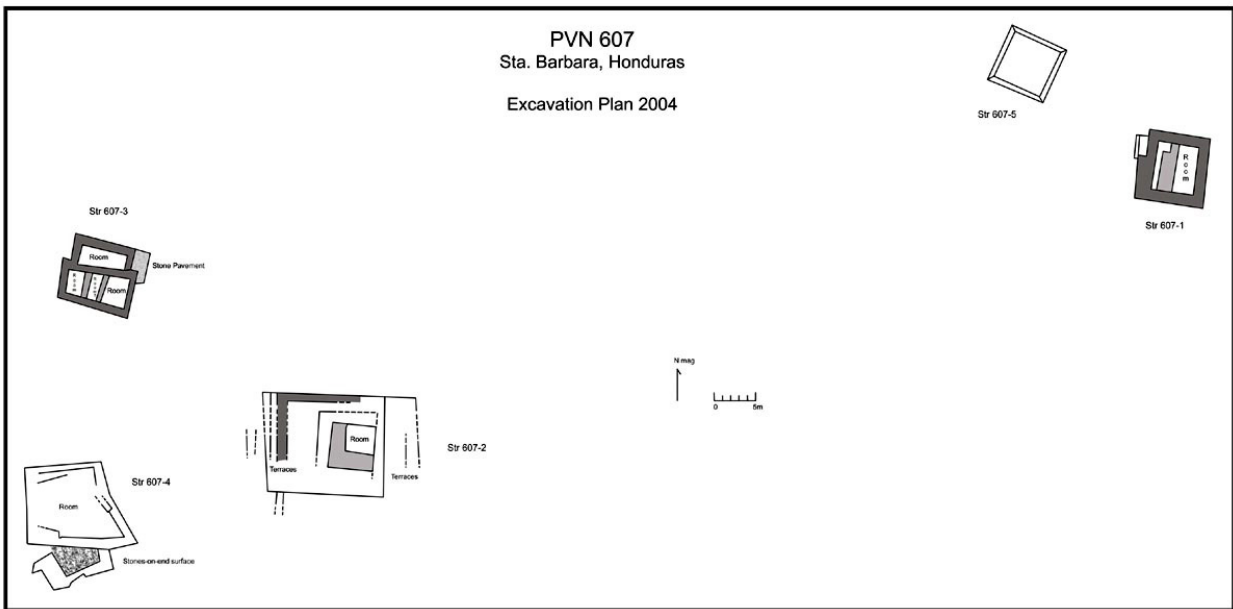

Figure 5. Site PVN 607 Excavation Plan.



Figure 6. Site PVN 607, Structure 1, Overview.

Structure 607-2, the largest building at the settlement, closes off the east side of the Site 607 patio. The platform's core is a stone-faced construction 0.8 m high, measuring 4 m by an estimated 3.5 m, and aligned 184 degrees ([Figure 7](#)). The summit room encompasses 2.5 x 2.65 m, most of which is filled by an L-shaped bench that is set against the west and south walls of the superstructure. This bench is ca. 0.2 m high, 0.8 m wide by 2.65 m long (west arm), and 1 m wide by 2.5 m long (south arm). A ca. 0.5 m high, stone-faced terrace wraps around the core platform on all sides save the east. The width of this unit varies: 0.95 m on the north; 2.4 m on the west, and 1 m on the south. Three low stone terraces or steps, 0.1–0.18 m high, 0.2–0.3 m wide, are built against the western terrace. Structure 607-2's basal dimensions by the end of this phase are 5.9 x 7 m.

At some later point in time, two stone-faced terraces, 0.18–0.22 m high, were appended to the previously sheer east flank. The basal, easternmost terrace is 0.7 m wide while the succeeding, higher example measures 1.25 m across. A 0.1 m high stone-faced terrace also was apparently added on the west, covering the earlier basal western riser. This new construction is 1.1 m wide. A low wall, 0.4 m across, extends at least 0.65 m south from the southern terrace. A disrupted stone pavement runs for an indeterminate distance east of the wall; this may be the floor of a surface-level room set against Str. 607-2's south face. By the conclusion of this interval, Str. 607-2 encompassed 5.9 x 10.2 m, excluding the southern wall, stood 0.8 m high, and retained its earlier alignment of 184 degrees. It was still faced by four terraces on the west, but two risers now ascended the eastern side.



Figure 7. Site PVN 607, Str. 2, Overview, taken from the south.

Structure 607-3 defines the patio's north edge; Strs. 607-2 and 607-4 are 9.2 m and 8.6 m to the southeast and south, respectively. Structure 607-3 was raised in the course of at least two building episodes. The earliest version is a stone-faced platform measuring 2.4 × 4.5 m and aligned 10 degrees ([Figure 8a](#) and [Figure 8b](#)). This 0.3 m high construction supported three narrow rooms set in an east-west line. The eastern and western enclosures measure 1.4 × 1.8 m and 0.9 × 1.5 m, respectively, while the central compartment covers 0.5 × 1.6 m. The building was expanded 1.6 m to the north in a later phase by the addition of a 0.3 m high stone-faced annex that measures 3.6 m across east-west.



Figure 8a. Site PVN 607, Str. 3, Overview, Northeast corner in foreground.



Figure 8b. Site PVN 607, Str. 3, Detail, West basal wall, northwest corner in foreground.

Structure 607-3 now was roughly T-shaped; the southern cross-bar being the core platform, covering 4.5 m east-west while the "leg" of the figure is 3.6 m east-west. Overall, the building covered 4 m north-south and retained its orientation of 10 degrees. The southern three rooms remained in use and were joined on the north by a large summit enclosure covering 1 × 2.7 m. A surface composed of densely packed small stones abuts the entire east side of Str. 607-3's north addition, extending to the northeast corner of the original core. This floor encompasses 1.75 × 2 m.

Structure 607-4, approximately 8.5 m east-southeast of Str. 607-2, closes the patio's southwest corner. This edifice seems to have started out as an earthen-floored, surface-level building delimited

by low stone foundations and open to the east and Str. 607-2 ([Figure 9a](#) and [Figure 9b](#)). At this stage, Str. 607-4 covered 4.9×5 m, its featureless interior encompassing about 3.6 m on a side, and was aligned between 264 degrees to 274 degrees. Later the eastern flank was sealed, the interior being filled with a mixture of stone and earth. This effort converted a surface-level building into a 0.4 m high platform that retained the earlier alignment. Subsequently, a U-shaped wall fashioned of unmodified stones set on end was appended to Str. 607-4's south flank. This wall measures 0.3–1.1 m wide and encloses an earthen-floored space 1.5×2.3 m bounded on the north by Str. 607-4's south facing. A 0.4 m wide gap separates the western portion of the unit from Str. 607-4's south wall, thus creating a possible, albeit very narrow, entrance to this surface-level enclosure.



Figure 9a. Site PVN 607, Str. 4, South end, viewed from the east.



Figure 9b. Site PVN 607, Str. 4, Northwest corner showing terracing.

All four of the investigated buildings were raised and used during the Late Classic. No clear signs of earlier occupation were noted. The vertically-set rocks found at Str. 607-4 are reminiscent of Early Postclassic architectural canons in the Naco and lower Cacaúlapa valleys, but corroborating evidence for occupation extending into this phase at Site 607 is still lacking.

Site 598

Site 598 is ca. 2.5 m west/southwest of Las Canoas, on the north bank of the Rio Chamelecon. The settlement sits on a terrace edge overlooking the river, a scant 20 m to the south ([Figure 10](#)). Site 598 is separated from the terrace supporting Las Canoas and Site 607 by a southern extension of the northern hills. The 18 structures comprising Site 598 vary in size from buildings that were apparently raised directly on ancient ground surface to a monumental platform standing ca. 2.5 m high. Together, the structures define two adjoining patios, a larger one on the west and a much smaller open space to the east. Structures 598-1 and 598-2 were excavated under the direction of L.A. Ellison and C. Webber this season, resulting in the clearing of 60 m². Both buildings are on the northern margin of the largest patio and were erected over a south-to-north ascent. They occupy intermediate positions in the settlement's structure size continuum.

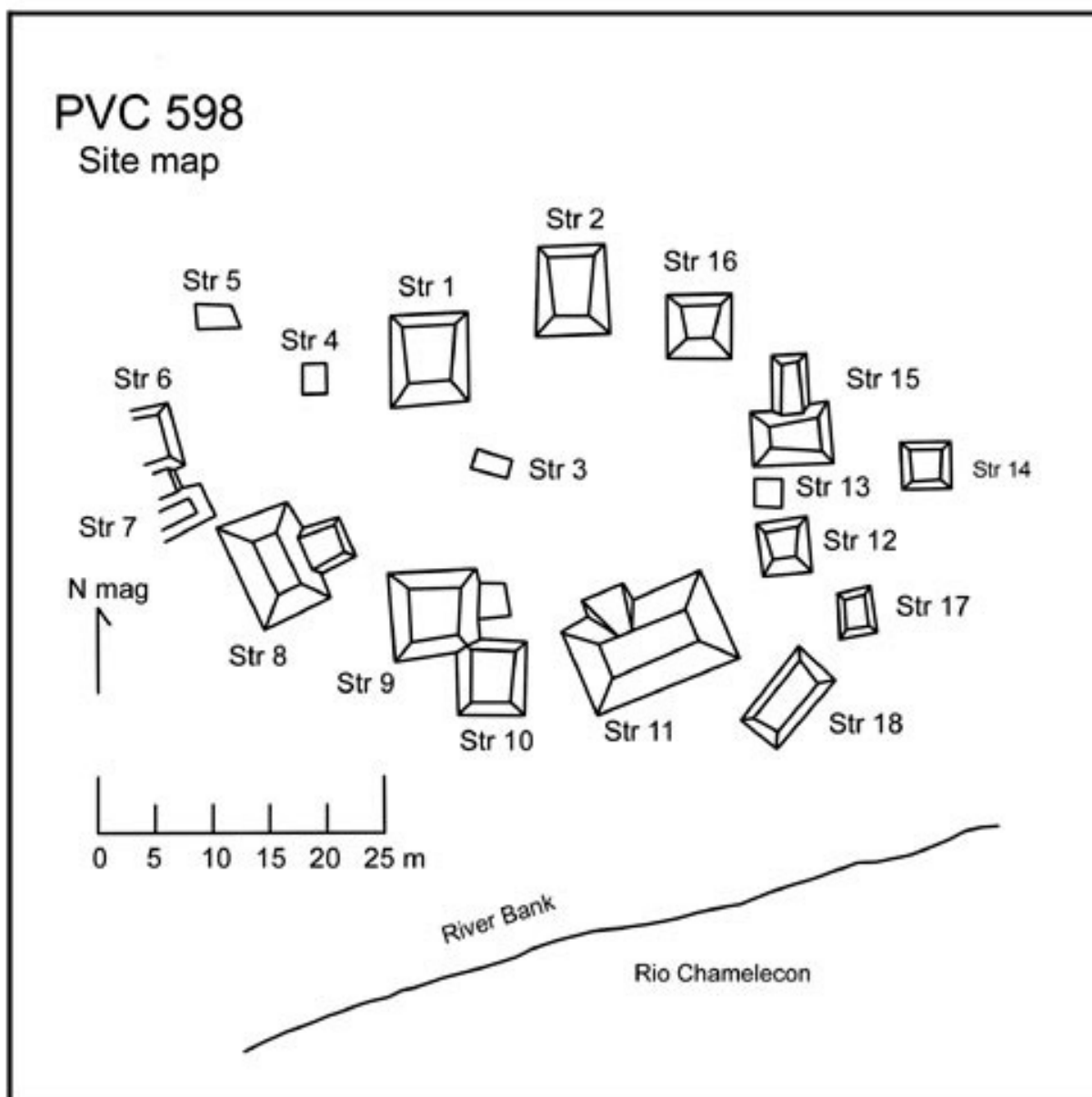

Figure 10. Site PVN 598 Site Map.

Structure 598-1 was apparently raised on a site of earlier construction. Structure 598-Sub1 is a 0.25 m high stone-faced platform that is stratigraphically prior to Str. 598-1 (Figure 11). Structure 598-Sub1 measures 3.32 × 3.65 m and is aligned 89 degrees. In addition, a 0.08 m high stone wall running at 72 degrees for at least 0.7 m was recorded below and south of Str. 598-1. The latter building was seemingly raised in a single construction effort. It is a stone-faced platform standing 1.2 m and 0.5 m high on the south and north, respectively, covering 5.69 × 6.34 m, and oriented 264 degrees (Figure 12a and Figure 12b). Structure 598-1 is topped by one large room that encompasses 17.5 m²; a 0.28 m tall by 0.85 m wide stone bench runs for 5 m along the entire length of the compartment's north

side. Three stone steps mount Str. 598-1's south, patio-facing flank while the north and west faces are ascended by two terraces each; the east seems to have but one, steep facing.

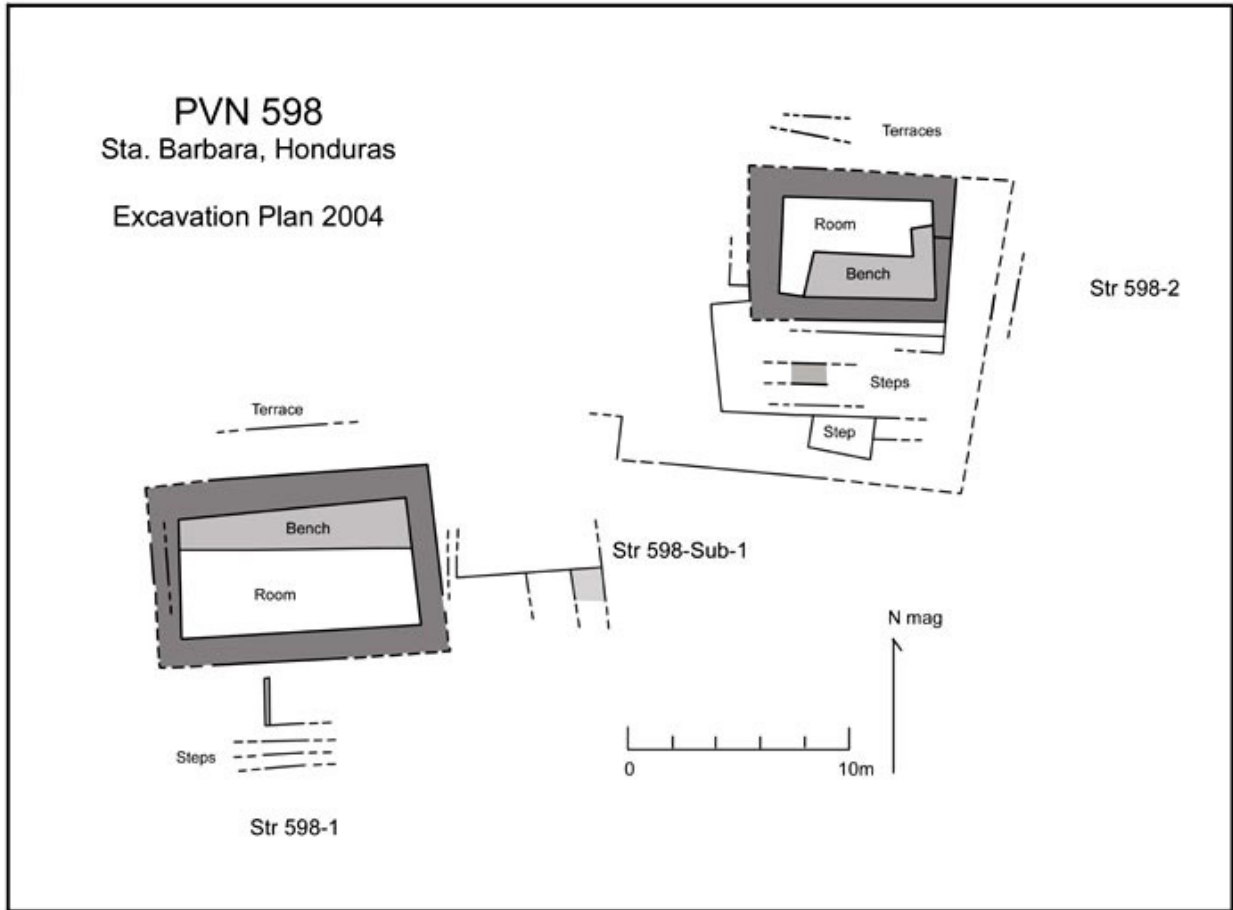

Figure 11. Site PVN 598 Excavation Plan.



Figure 12a. Site PVN 598, Str. 1, Viewed from the east, showing terracing.



Figure 12b. Site PVN 598, Str. 1, Viewed from the west, showing summit room and terracing.

Structure 598-2 is a stone-faced platform that measures 7 × 7.5 m and stands 1.3 m and 1.6 m high on the north and south, respectively. The building is oriented roughly 271 degrees ([Figure 13a](#); [Figure 13b](#) and [Figure 13c](#)). A staircase with five risers ascends to the summit on the south. The superstructure consists of a large earthen-floored room that encompasses 3.5 × 5.5 m. An L-shaped, stone bench occupies most of the south wall of the enclosure. This construction stands at a preserved height of 0.1 m and is 0.95 m wide by 2.8 m long east-to-west; its northern extension projects 0.7 m from the bench's east end and is 0.45 m wide.



Figure 13a. Site PVN 598, Str. 2, Detail, Stairs, south side.



Figure 13b. Site PVN 598, Str. 2, Detail, North summit wall.

Both Strs. 598-1 and 598-2 were built and used during the Late Classic.



Figure 13c. Site PVN 598, Str. 2, Detail, North basal facing.

Site 120

Site 120 consists of 25 modest stone constructions (none more than 1 m high) built on and around three large earthen rises, each 2–3 m high, on the west bank of the Rio Cacaupala ca. 200 m south of that stream's confluence with the Rio Chamelecon ([Figure 14](#) and [Figure 15](#)). A small patio group defined by four platforms is located on the settlement's southwest margin while another possible patio is on the far south. In the central cluster of buildings is one clear patio group, and a second possible one. The remaining buildings are scattered without any clear plan in a roughly N-S line. A total of eight structures was excavated here in 2004 under the direction of L.A. Ellison and C. Webber, resulting in the exposure of 140 m² of prehistoric deposits.

Structure 120-1 is one of these earthen rises ([Figure 15](#)). It stands about 3.5 m high and is located on the site's north-western edge. Our attention was drawn to this building because a cobble construction on its summit suggested that this had been a locus of human habitation. Excavation here revealed that the aforementioned stone construction was a thin veneer over what was an earthen edifice apparently raised in one building effort. Aside from the enigmatic stone summit architecture, which appears to have been a pavement, little remains of Str. 120-1's architectural form.

Structure 120-2 is in the settlement's middle cluster. It is set on the east face of a low rise that, on excavation, turned out to be an earthen construction long predating Str. 120-2's erection. The rise itself is called Str. 120-6, while the designations Strs. 120-2, -4, -5 refer to the cobble constructions on

Str. 120-6. It was these three cobble constructions that drew our attention to Str. 120-6, because what we now know is an artificial construct appeared to be a natural rise.

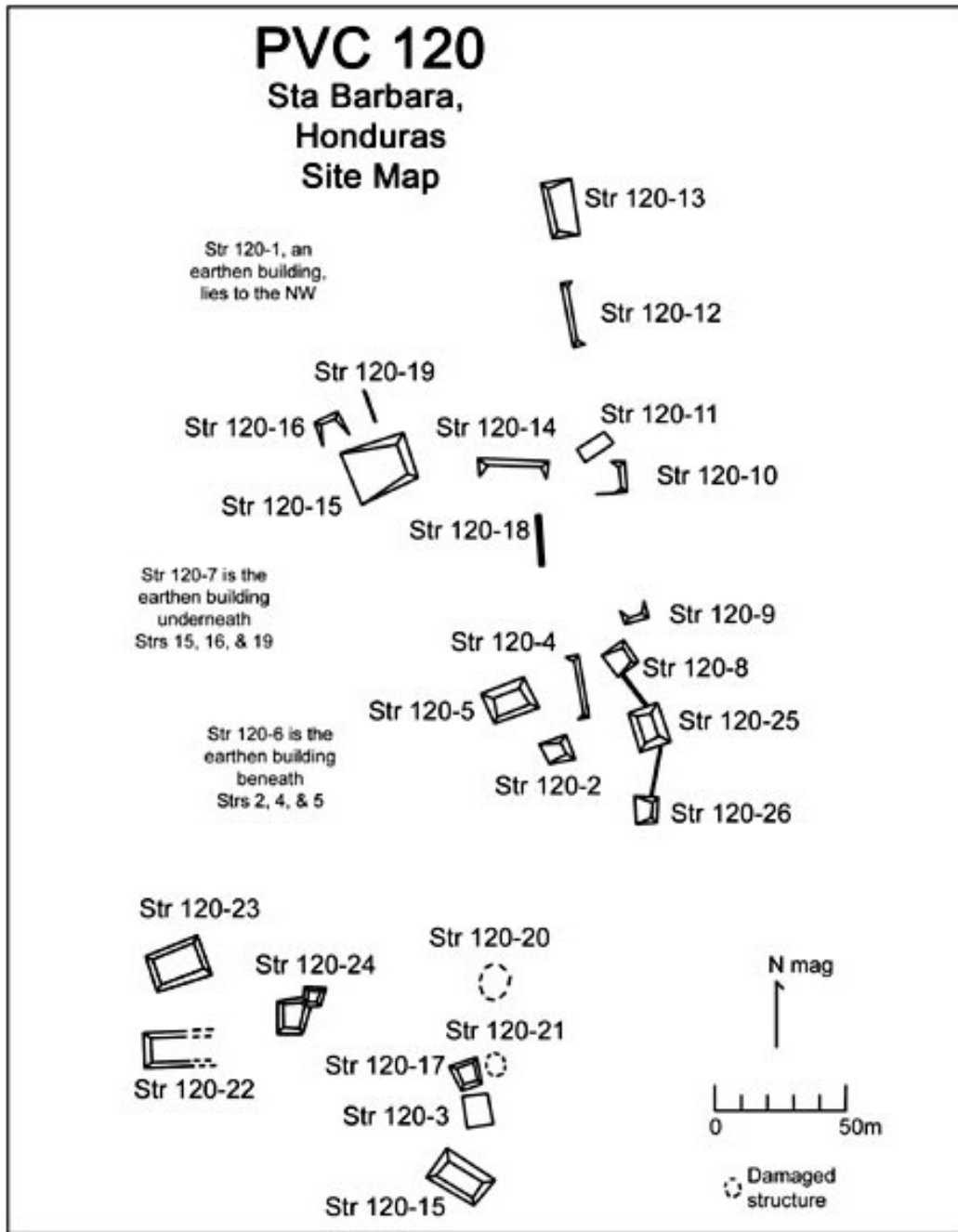

Figure 14. Site PVC 120 Site Map, Structures only (PVC: Proyecto Valle de Cacaupala).

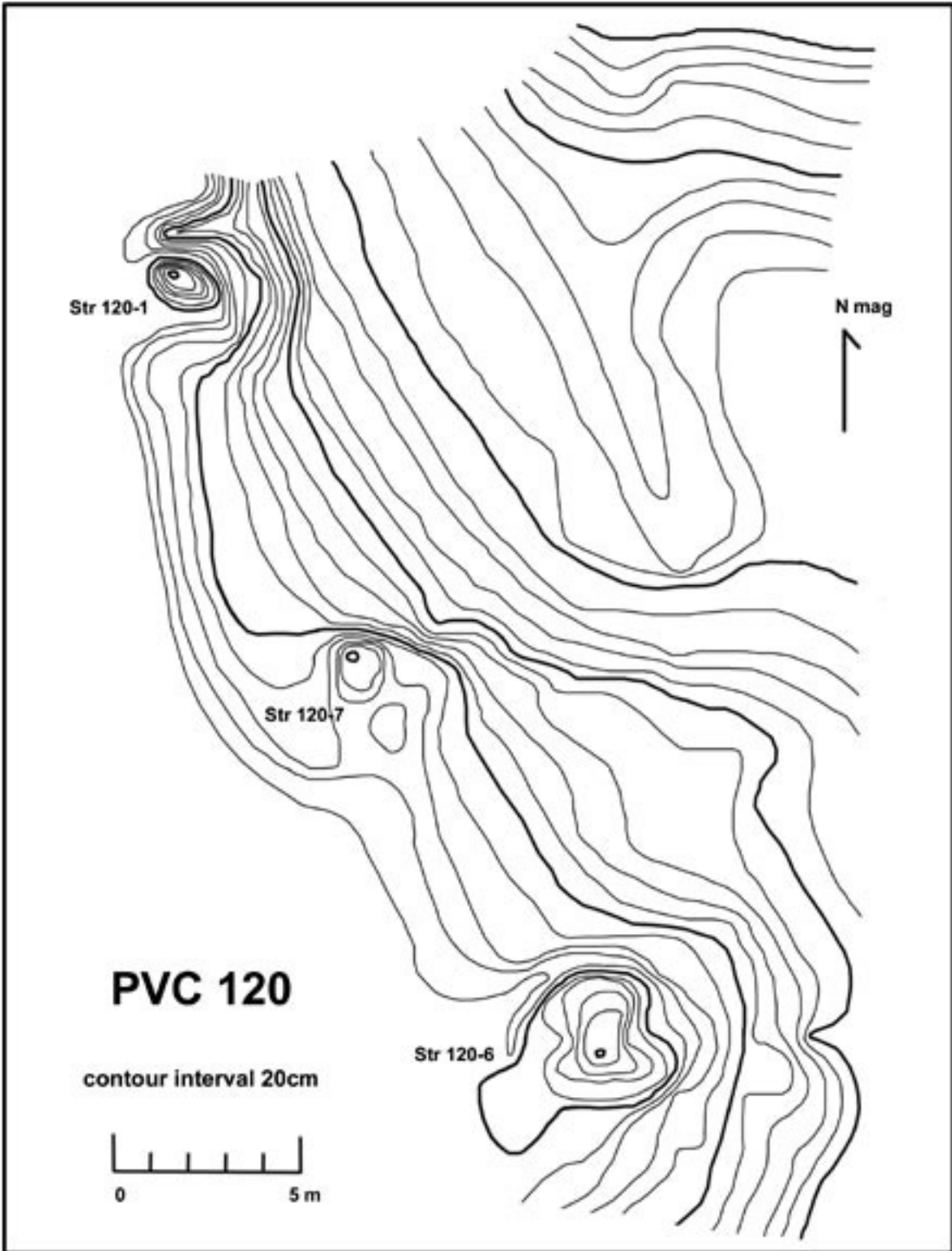

Figure 15. Site PVC 120 Contour Map.

Structure 120-2 began as a 0.28 m high stone-faced platform measuring 2.9 × 5.2 m and oriented 7 degrees (Figure 16). The summit is paved with stones; it is unclear whether it was ever enclosed (Figure 18). A 0.6 m wide terrace bounded by stone walls was subsequently added to the platform's east, downslope face. This construction is inferred to have fronted most of the eastern facing, stopping 0.1 m shy of the southeastern pavement noted below. The terrace may have been designed to shore up Str. 120-2 where it was most susceptible to erosion. A cobble surface wraps around the building's southeast corner, measuring 1.7 m on a side.

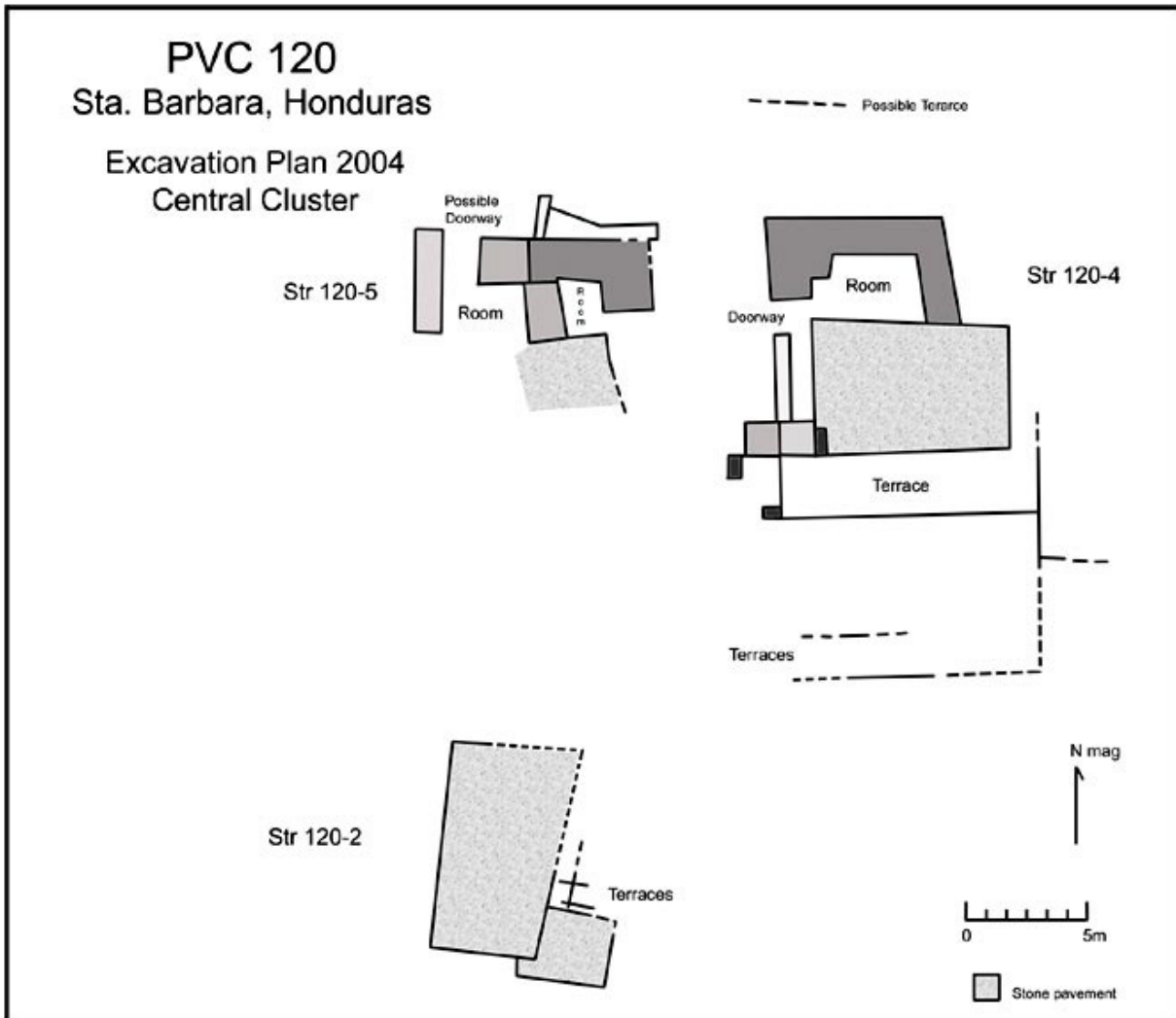

Figure 16. Site PVC 120 Excavation Plan, Central Cluster.

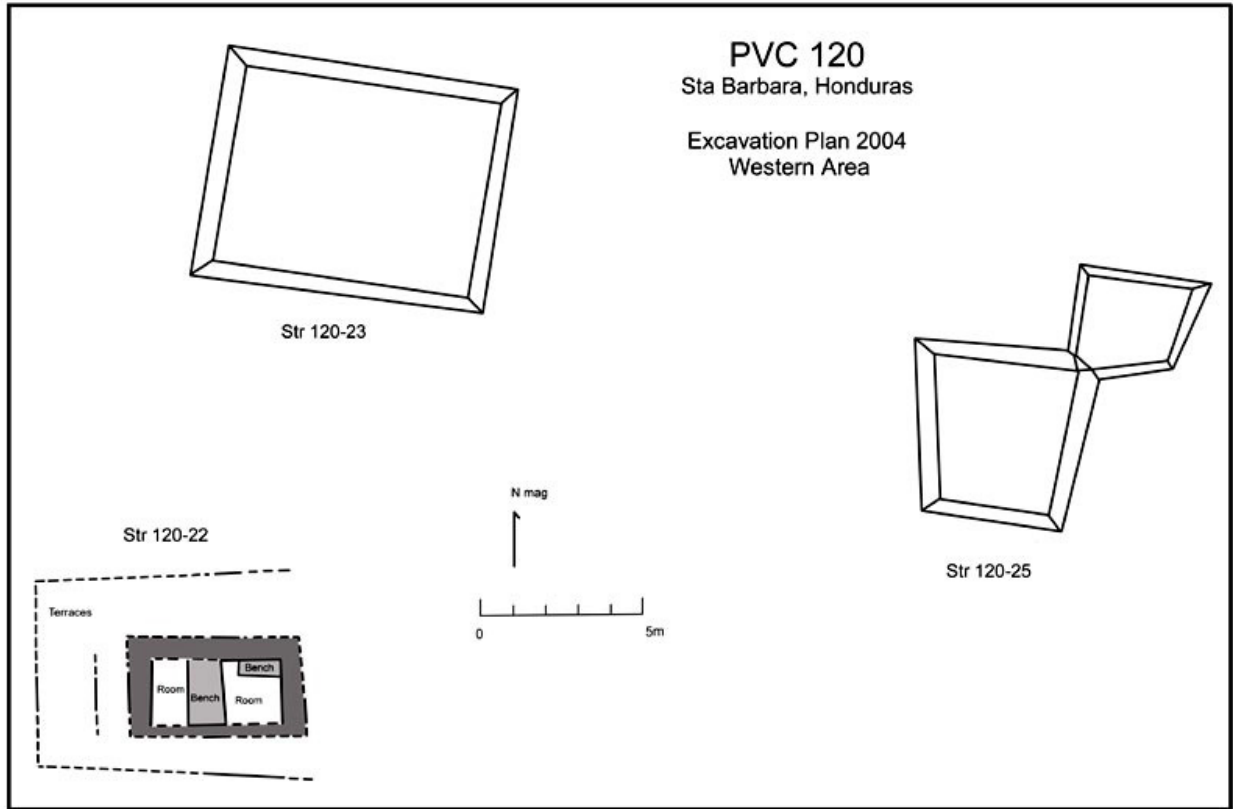

Figure 17. Site PVC 120 Excavation Plan, Western Site Area.

Structure 120-4, on the eastern edge of Site 120, sits atop the Str. 120-6 earthen rise. The building began as a 0.25 m tall stone-faced and -surfaced platform that measures 3.3 × 4.8 m and is aligned 82 degrees ([Figure 16](#)). Its southwest corner may have originally been inset 0.25 × 0.65 m but was sealed prior to the next round of additions. Among these renovations is an 0.18 m high, 1.55 m wide stone-faced terrace that runs along the entirety of the platform's southern (downslope) face and intersects a 0.7 m wide terrace that fronts the building's east side ([Figure 19a](#) and [Figure 19b](#), shown below).



Figure 18. Site PVC 120, Str. 2, Northwest corner and west side, showing casual Late Classic construction that overlies Preclassic deposits.



Figure 19a. Site PVC 120, Str. 4, Viewed from the south.



Figure 19b. Site PVC 120, Str. 4, Viewed from the east showing summit room.

Later in time, walls were added to the platform's west and north flanks to create an L-shaped, earthen floored, surface-level room that wraps around the core on these sides. A doorway 0.85 m wide in the western foundation, opposite the platform's northwest corner, provided access to this space which measures 0.6 × 3 m (west side) and 1.55 × 2.7 m (north flank). The footing bounding this area is particularly wide at its northwest corner, encompassing 1.4 m on a side. This especially substantial portion of the bordering wall might have doubled as a support for perishable upper construction and a bench. A smaller earthen-floored compartment, covering 0.9 m east-west by 1.2 m north-south, was erected on ground surface off the west side of the southern terrace. This enclosure was entered through an 0.85 m wide doorway in its southwest corner. Hints of other surface-level rooms extending west of Str. 120-4 were noted, though the dimensions of these late constructions were not determined.

By the end of occupation, Str. 120-4 encompassed an estimated 6.5 × 7.3 m and retained its original orientation. The building was also the focal point for a warren of rooms built on ancient ground surface, extending west and north of the edifice. Structure 120-5 seems to be part of this aggregate of living spaces ([Figure 20](#), shown below).



Figure 20. Site PVC 120, Overview of Strs. 4 and 5, taken from the west.

Structure 120-5 is 2.9 m west of Str. 120-4. Deep probes beneath the surface-visible stone construction revealed a 1.75 m thick cultural deposit that buried a surface of medium-size river

cobbles. Topping this earthen unit is a series of surface-level rooms delimited by cobble wall foundations ([Figure 16](#)). The two enclosures fully uncovered in our investigations measure 1.04 × 1.43 m and 2.25 × 3.15 m and are open on the south. Walls bounding additional rooms run out to the west and south beyond excavation limits.

A probe was also sunk into the summit of Str. 120-6; it continued to a depth of 3 m at which point culturally sterile soil was encountered. It appears that Str. 120-6 is a 2.2 m high construction raised in a single episode; there was no sign of any breaks in the building effort. The edifice was erected atop an ancient living surface ([Figure 21](#)) below which artifacts were found for an additional 0.8 m. No clear architectural features aside from the earth fill were noted in our test.



Figure 21. Site PVC 120, Str. 6, Preclassic surface.

Structure 120-7 is an earthen construction on the settlement's northwestern edge. A 2.1 m deep probe sunk into the building's summit revealed two construction phases ([Figure 22](#)). The earliest recognized building episode was associated with an earthen terrace that ascends vertically 0.64 m above a tread at least 0.45 m wide. The latter is covered with a 0.04 m thick layer of carbon-rich soil. The terrace's upper surface is burnt and is minimally 1.45 m across. This version of Str. 120-7 is at least 1.13 m high. The upper terrace tread was later capped with a 0.38 m thick deposit of earth,

which raised the building to, minimally, 1.51 m high. Later still, this terrace system was buried by 0.3–1.38 m of dirt as part of an effort to increase Str. 120-7's size or terminate its use.

Structure 120-8 appeared on the surface as a line of stones running north-south and located ca. 20 m east of Str. 120-7. This construction seems to have been a 0.43 m high wall running 9.4 m (1.2 m of which was exposed) aligned at 358 degrees ([Figure 23](#)).

The three earthen mounds excavated at Site 120 (Strs. 120-1, -6, and -7) were apparently built during the Middle Preclassic (at least 800-400 B.C.). Two were seemingly raised in a single construction effort but Str. 120-7 was built in several phases. The Middle Preclassic occupation of Site 120 was fairly extensive; in addition to the mounds themselves, deposits dating to this phase were found beneath Str. 120-3 on the site's southwest edge. After a prolonged hiatus, people returned to the site in the Late Classic when they erected their modest buildings on and around the earlier edifices.

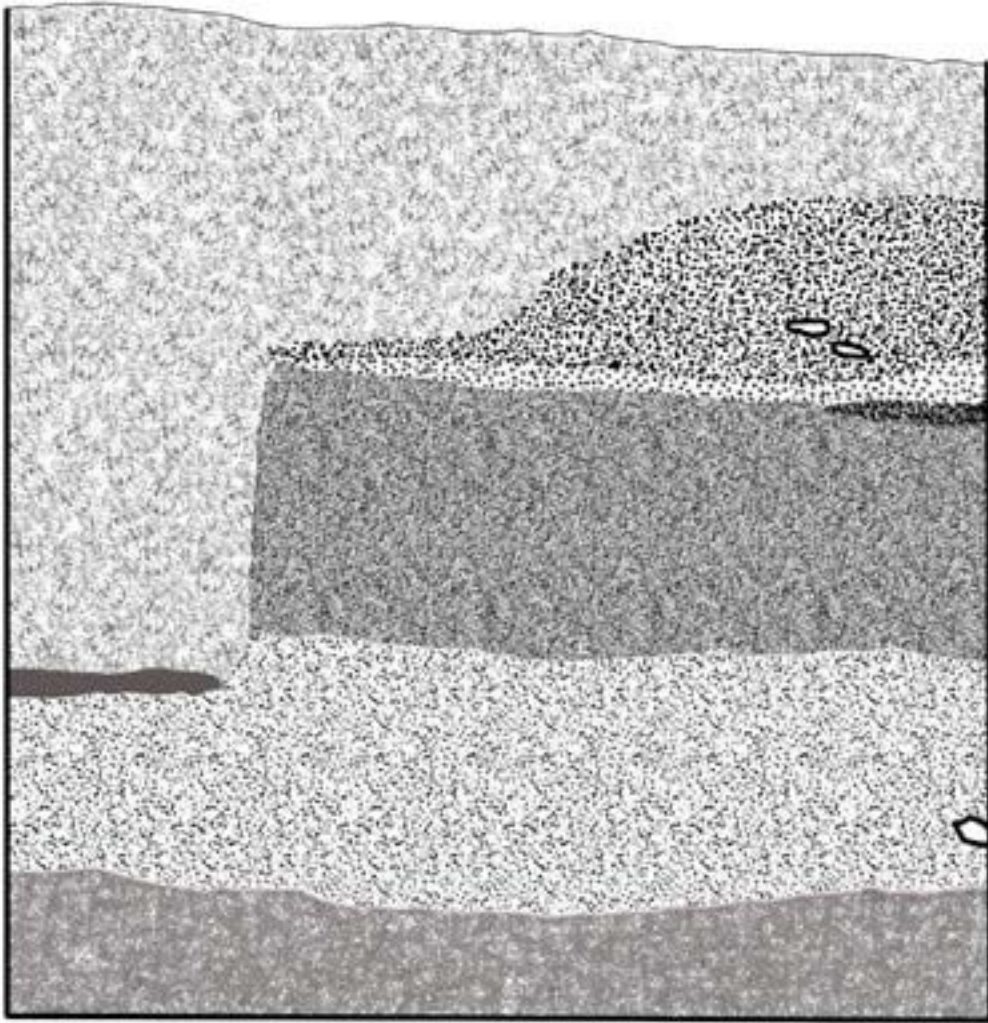

PVC 120
Str 7 Section, W Side
Showing Preclassic Earthen Construction

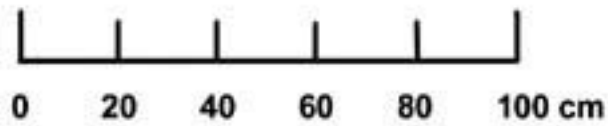

Figure 22. Site PVC 120, Str. 7, Section, west side showing Preclassic earthen construction.



Figure 23. Site PVC 120, Str. 18, Showing casually-made Late Classic construction.

Structure 120-22 is in the patio group on Site 120's southwest margin ([Figure 14](#)). Like the other members of this cluster, Str. 120-22 has been damaged: its eastern flank was mined for stones. Structure 120-22 is, however, the best-preserved building facing the patio and was chosen for excavation partly for this reason. The platform stands 0.58 m high, covers 6.4 m north-south by roughly 7.7 m east-west (the east wall was not clearly identified), and is aligned at 91 degrees. It is bounded on the north, west, and south by terraces that are 0.3–0.4 m high and 1.95 m, 1 m, and 1.15 m across, respectively ([Figure 17](#)). The summit consists of at least two earthen-floored rooms set in an east-west line. These enclosures measure 1.2 × 2 m and 1.6 × 1.8 m and are separated by a 0.14 m high, 1.05 m (east-west) by 2 m (north-south) wall whose significant width suggests that it may have been a bench. A 0.5 m wide stone shelf occupies the northeast corner of the eastern compartment and runs 1.3 m west from its intersection with the enclosure's east wall. A construction composed of stones set vertically on end abuts Str. 120-3's western basal facing and extends 1.7 m in this direction.

Site 161

Site 161 is 100 m south, and across the Rio Cacaupala, from Site 120. The ten constructions comprising this settlement (eight standing buildings and two rock concentrations that likely represent destroyed buildings) are arranged around two adjoining plazas running roughly east-west ([Figure 24](#)). None of the structures is more than 1.2 m high. Two constructions were dug here in 2004 under the direction of L.A. Ellison and C. Webber, resulting in the exposure of 75 m² of prehistoric deposits ([Figure 25](#)).

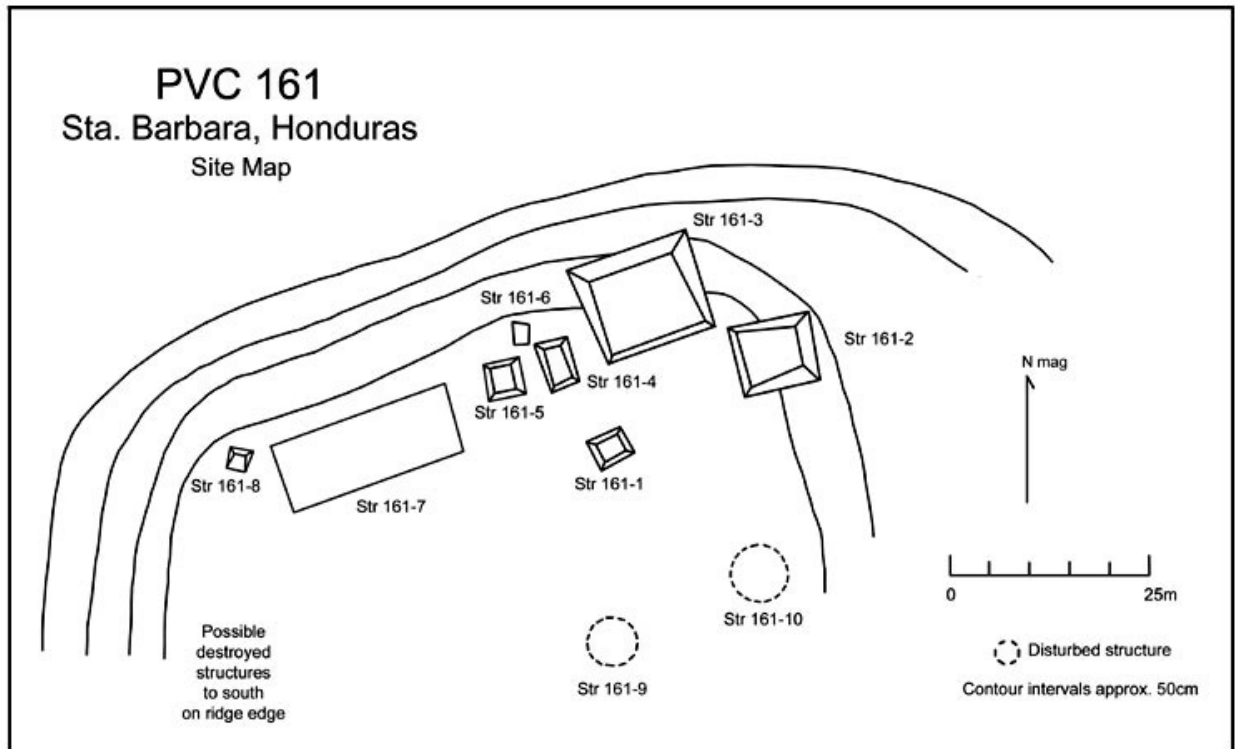

Figure 24. Site PVC 161 Site Map.

Structure 161-1 separates the two plazas. The earliest construction identified here is a 0.1 m high, 0.3 m wide stone wall that runs for at least 1 m at an orientation of 50 degrees. Buried by later architecture, only a limited portion of this unit was exposed.

Subsequently, a 0.5 m high stone-faced platform measuring 3.4 × 4.4 m and aligned 60 degrees was raised. The platform's summit was divided into two adjoining rooms set in a northeast-southwest line; the southwest example covers 1.5 × 2.3 m while its northeast neighbor encompasses 1.3 × 2.4 m. A building not visible on ground surface, Str. 161-Sub1, was found 2.7 m south of Str. 161-1. Structure 161-Sub1 is a 0.3 m high stone-faced platform measuring 4.3 × 4.93 m and aligned 70 degrees. The two rooms that occupy the platform's summit are set in a northeast-southwest line and measure 1.6 × 3.5 m (the southwestern room) and 1.85 × 3.5 m (its northeastern counterpart). Structures 161-1 and 161-Sub1 were subsequently joined by the construction of a stone pavement that covers a total area of roughly 7.4 × 20 m. The edges of this surface are ill-defined.

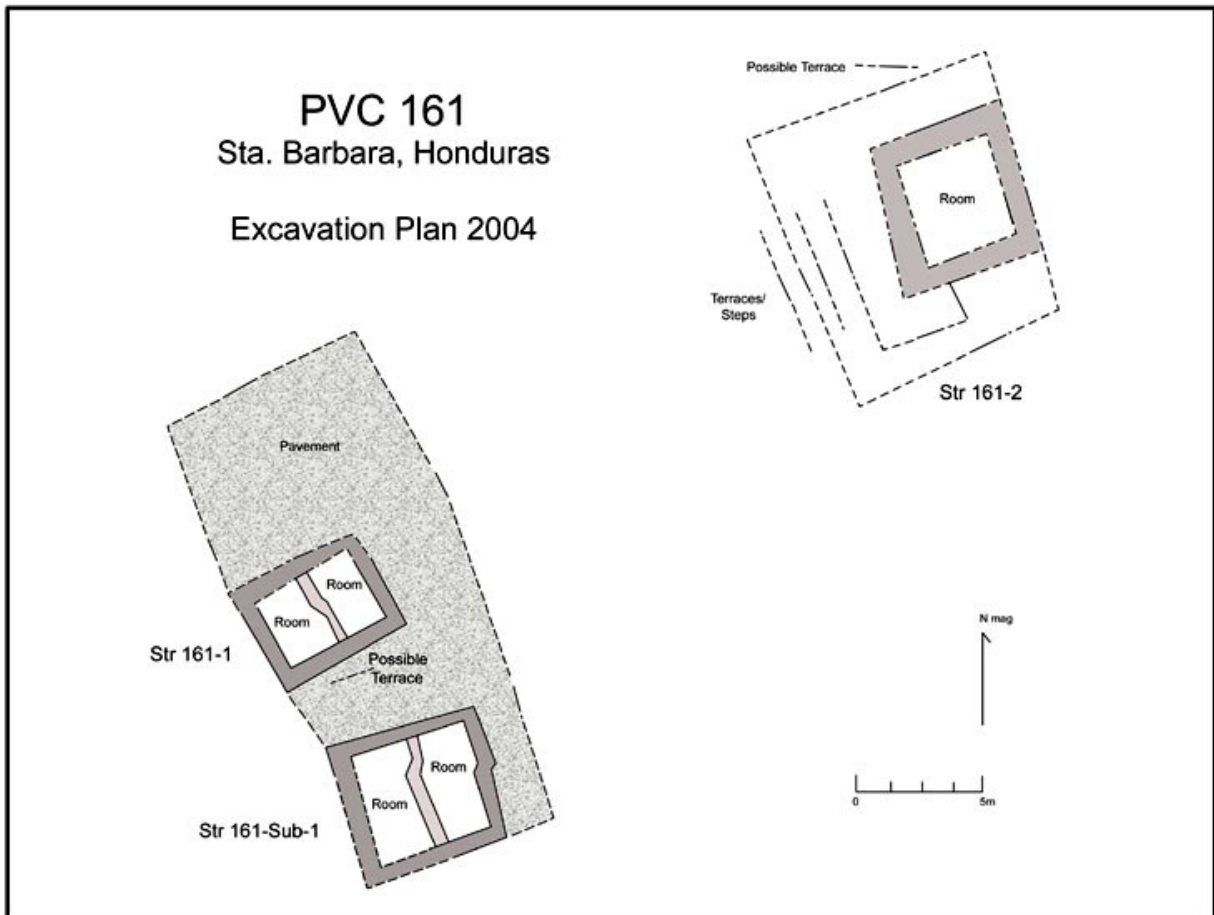

Figure 25. Site PVC 161 Excavation Plan.

Structure 161-2 is on the eastern margin of the east patio, ca. 12 m west of Str. 161-1. This stone-faced platform stands about 0.8 m high, measures 7.6 × 8.6 m, and is oriented 340 degrees. Three low (0.2–0.3 m high) stone-faced terraces ascend the platform's west, patio-facing side (Figure 26); one terrace each graces the northern and southern flanks while on the east a single steep ascent rises to the summit. The western terraces may have doubled as steps leading to the featureless summit room which covers 2.95 × 3.3 m.



Figure 26. Site PVC 161, Str. 2, Terraces.

Following this initial construction, a 0.3 m high terrace was added to the west flank completely obscuring the original basal facing on this side. This renovation resulted in a basal terrace 1.3 m wide and increased the building's overall dimensions to 8.3 × 8.6 m. No change in Str. 161-2's orientation was noted. Later still, after the eastern basal wall had begun to deteriorate, a casually fashioned addition of stone was appended to this side of the platform, extending 2.4 m east of the basal facing.

Site 161 was occupied by at least the Late Classic when the initial versions of Strs. 161-1, 161-2, and 161-Sub1 were raised. Additions to these edifices seem to have been made in the Terminal Classic.

Site 162

Site 162 occupies the summit of a steep hill ca. 1.5 km southwest of, and 75 m above, El Coyote. Four of Site 162's seven small constructions surround a patio, the remainder being scattered to the north of this aggregate. Most of the available flat land on the promontory is taken up by the settlement itself; the surrounding terrain consists of steep escarpments overlain by thin soils pierced by numerous rock outcrops ([Figure 27](#); [Figure 28a](#) and [Figure 28b](#)). The closest source of perennially running water is the Rio Cacaupala, about 1.25 km to the east. Two structures were dug here, resulting in the exposure of 100 m² of prehistoric deposits.

Structure 162-1 occupies the southwest margin on the settlement and of the patio delimited by Strs. 162-1 through -4. The earliest architecture identified in our investigations here is a semi-circular stone surface that measures 2.35 m in diameter ([Figure 29](#)). It was found protruding 0.65 m out from beneath Str. 162-1's southwest side and continued under that building; the pavement's full dimensions were not uncovered.



Figure 27. Valley view from Site PVC 162.

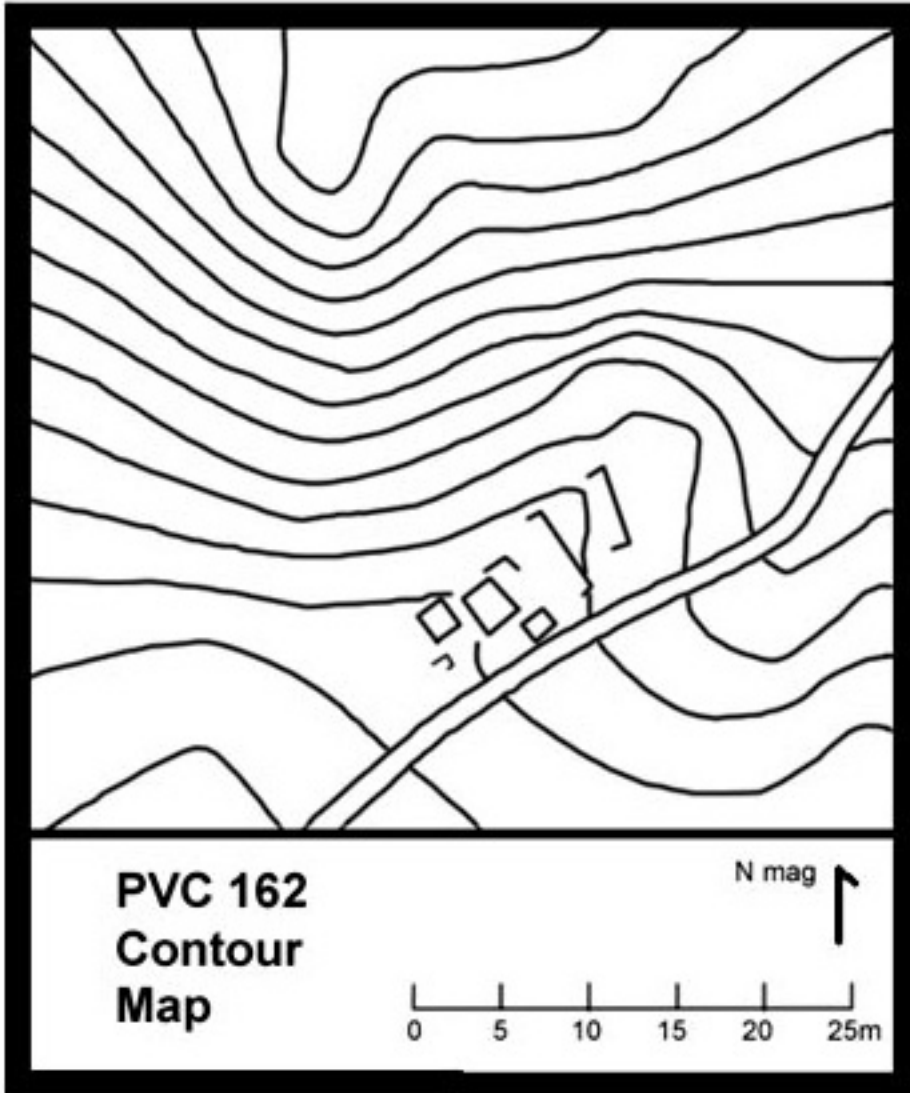

Figure 28a. Site PVC 162 Site Map, Contours.

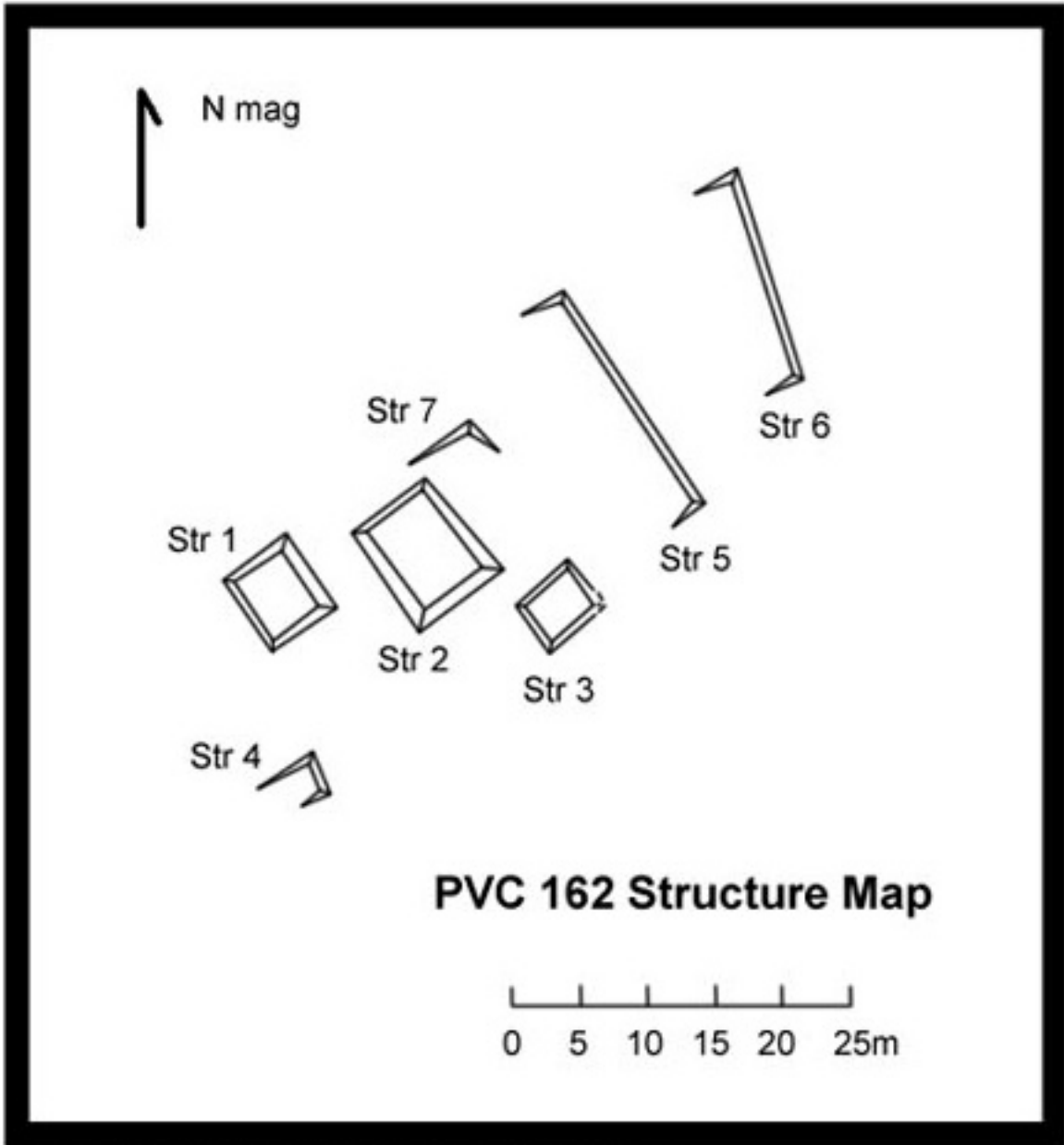

Figure 28b. Site PVC 162 Site Map, Structures.

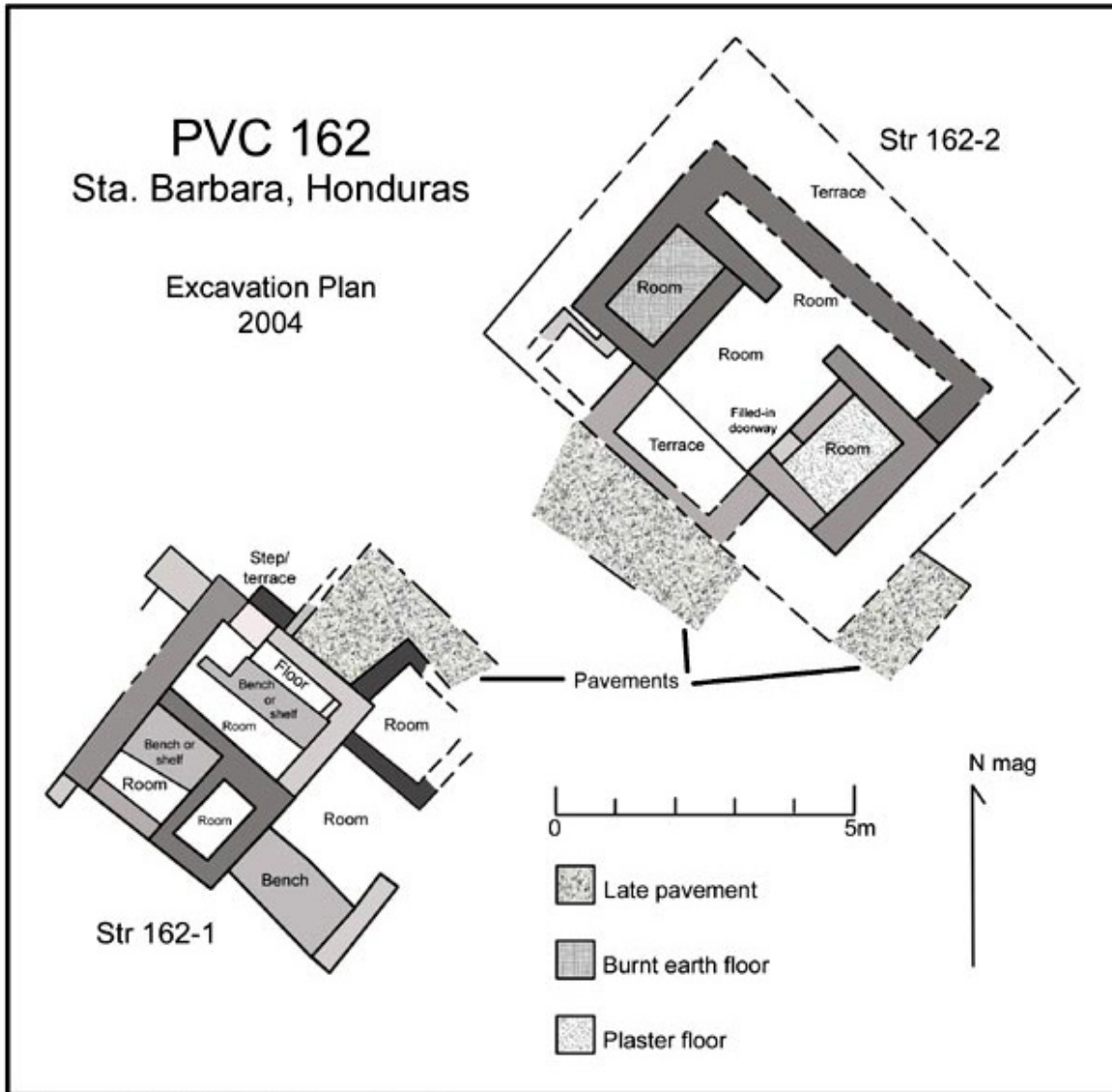

Figure 29. Site PVC 162, Excavation Plan.

Subsequently, a 0.43 m high stone-faced and -filled platform measuring 1.4 × 2.25 m and aligned 128 degrees was erected (Figure 30). Adjoining this construction on the northwest is a surface-level, earthen-floored room open to the southwest and covering 1.3 × 1.97 m (interior dimensions). Somewhat later in the occupation history, the room was sealed on the southwest, filled in, and a 0.28 m high stone bench was built against the northeast wall, encompassing 0.9 × 1.3 m.

Next, a stone-faced terrace standing 0.12 m high and measuring 3.3 m southeast-northwest was added to the building's northeast face, extending 2 m in this direction. The terrace covers the entirety of Str. 162-1's northeast flank, including the core platform and the northwest addition, and its construction increased the building's dimensions to 3.2 × 4.1 m. The original orientation was maintained. A 0.16 m high stone bench runs 1.7 m southeast-northwest across the approximate center of the terrace. This construction is 1.0 m wide and seems to be bounded on the northwest by a cubicle measuring 0.6 m on a side. Entrance to this diminutive compartment is restricted by the

bench on the southeast, the terrace walls on the northeast and northwest, and a 0.2 m thick, 0.55 m long extension of the bench on the southwest.



Figure 30. Site PVC 162, Str. 1, Overview.

A room, whose earthen-floored interior encompasses 1.9 × 2.6 m, was later appended to the core platform's southeast side. This addition is bounded by stone foundations for perishable upper walls, was entered through a 1.2 m wide door in its east corner, and has a 0.7 m wide stone-faced bench that covers the entirety of its southwestern wall (1.9 m long). Later still, another earthen-floored compartment was raised northeast of the aforementioned enclosure off the east corner of Str. 162-1's northeastern terrace. This room's interior dimensions are 1.4 × 1.5 m and it lacks built-in furniture. The door may have been in the east corner, though this notion was not tested. A small earthen-floored compartment, measuring 0.6 m across southeast-northwest, may also have been added to Str. 162-1's northwest flank at this time. Throughout these renovations, Str. 162-1 maintained its initial orientation.

The final construction attested to at Str. 162-1 is the addition of a cobble surface that extends 2 m north of the building. The limits of this late rough pavement are ill-defined.

Structure 162-2, the largest edifice at the settlement, is 5.85 m northeast of Str. 162-1 and delimits the southeast side of the patio bounded by Strs. 162-1 through -4. The land on which Str. 162-2 was raised rises markedly from north to south and east to west. The earliest version of Str. 162-2 identified in our excavations is a 0.3 m (northwest), 0.5 m (southwest), 0.54 m (southeast) and 0.8 m high

(northeast side) stone-faced platform measuring 3.7 × 6 m and oriented 120 degrees. Its summit was divided into four rooms, three of which are set in a southeast-northwest line on the southwest ([Figure 31](#)). These enclosures cover: 1.2 × 1.7 m (southeastern), 2.1 × 2.2 m (central), and 1.2 × 1.8 m (northwest). The southeastern and northwestern compartments have floors of white plaster on which evidence of burning was noted, possibly from hearths ([Figure 32](#)). The earthen-floored central enclosure was open on the southwest towards Str. 162-1 and the patio while a formal doorway 1.3 m wide provided access into a long, narrow, earthen-floored compartment on the northeast; this room covers 0.55 × 4.9 m. A terrace or step 1.2 m wide projects 1.3 m southwest from the platform and is centered on the central room.



Figure 31. Site PVC 162, Str. 2, Overview, taken from southwest.



Figure 32. Site PVC 162, Str. 2, Detail, East room with plaster floor.

A 0.26–0.42 m high stone-faced terrace was later added on all sides of the platform expanding Str. 162-2's basal dimensions to 6.3 × 7.8 m. This renovation did not change the platform's orientation, but it did incorporate the southwestern projection into the southwest terrace line. The terrace was then buried on the southwest and for 2 m northeast of its south corner by a casually fashioned stone construction that is about 0.25 m high. This addition extended 1.5 m southwest and 1.1 m southeast of the terrace though its margins are unclear. A similar late construction was recorded on Str. 162-1's northeast face; both additions are roughly contemporary.

Site 162 was occupied solely during the Late Classic.

Craft Production

Investigations conducted at Sites 607, 598, 120, 161, and 162, in conjunction with research pursued at Las Canoas, El Coyote, and two other small settlements in the Chamelecon drainage (Sites 599 and 602) during the 2004 field season, cast new light on the area's Late Classic through Early Postclassic political economy. Specifically, we can begin to discern how craft production figured in contests for power within the middle Chamelecon and lower Cacaupala valleys. The crafts for which we currently have the most data are: ceramic manufacture (including pottery vessels and figurines);

obsidian blade knapping; and copper processing. Please remember that analyses are ongoing and the interpretations offered here are subject to revision as the work progresses. Vague as the resulting picture certainly is, however, its emerging outlines suggest that crafts played variable roles in structuring political and economic relations within one polity through time. In addition, specialized manufacture was differentially significant in the political economies of even neighboring contemporary realms in Southeast Mesoamerica. Blanket generalizations about the political and economic significance of craft production, even within this restricted portion of the world, therefore, may not be warranted.

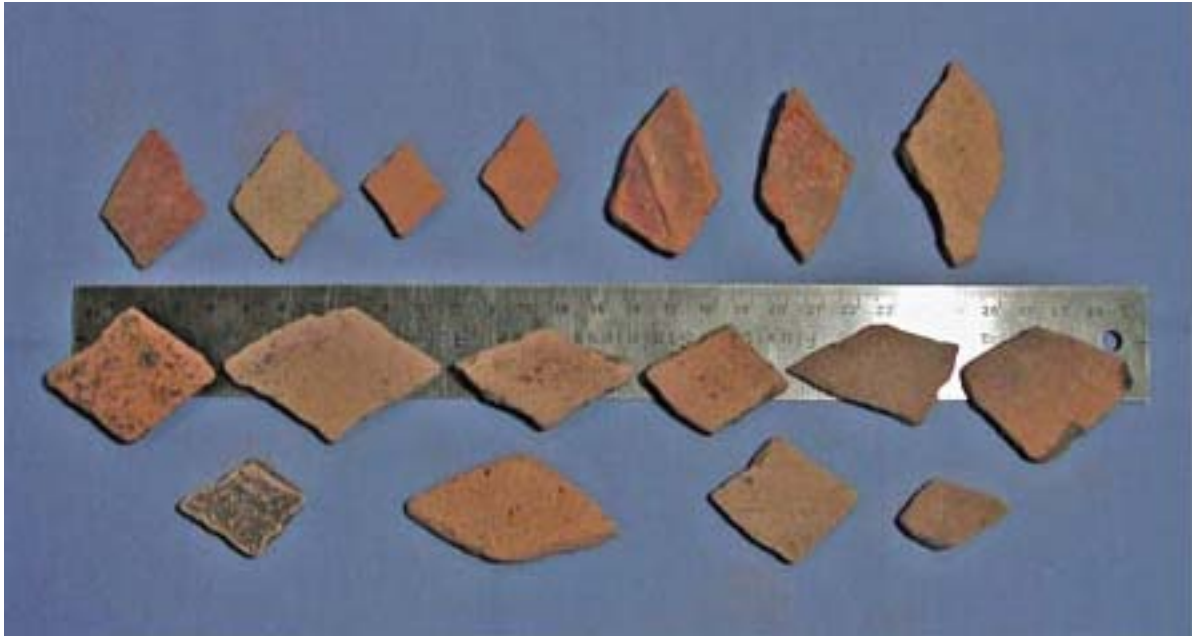

Figure 33a. Assortment of diamond-shaped tools made from potsherds.

Ceramic Production

Evidence for pottery production in the research area dates primarily to the Late Classic and comes in the form of manufacturing debris (ash and large quantities of broken sherds in particular) and implements, especially vessel fragments recycled as tools used in shaping vessels (Lopez Varela *et al.* 2001; [Figure 33a](#), shown above; [Figure 33b](#) through [Figure 33g](#), shown below) and potstands that supported containers during final finishing and firing. No firing facilities were recorded at any of the excavated sites in this or previous years.



Figure 33b. Flat edge, possibly ground.



Figure 33c. Wear on corner of rectangular tool.

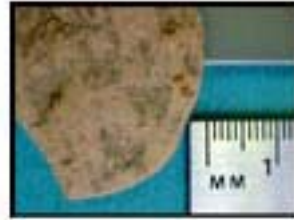

Figure 33d. Worn point, diamond-shaped tool.



Figure 33e. Wear on large spall.



Figure 33f. Opportunistic tool from PVN 607.

Figure 33g. Close-up, wear on PVN 607 opportunistic tool.

Potstands comprise a particularly distinctive artifact class that we have not seen in earlier work at Late Classic pottery workshops in the Naco valley. They conform to a fairly standard design consisting of a flaring base surmounted by a straight neck terminating in a flat rim (Figures 34a through Figure 34f, shown below).



Figure 34a. Purpose-made potstand, PVC 120.



Figure 34b. Potstand made from recycled flared-neck jar, showing discoloration due to reheating and baked-on clay, PVC 161.



Figure 34c. Purpose-made potstand showing slight discoloration from reheating, PVN 607.



Figure 34d. Purpose-made potstand showing discoloration from reheating, PVN 607.



Figure 34e. Purpose-made potstand, extensively discolored, with baked-on clay, PVN 202 (Las Canoas).



Figure 34f. Extensively discolored potstand with baked-on clay, made on recycled jar, PVN 202 (Las Canoas).

Clay is often found spattered and burnt on the exterior surfaces of these items, especially their bases. As many as three layers of clay have been noted baked onto potstands, suggesting that some were used multiple times. This pattern implies that potstands supported vessels while they were still wet and being shaped. That the clay splatters resulting from this stage were baked onto their surfaces, implies that potstands held vessels when they were fired. Despite the excavation of two Late Classic pottery kilns at La Sierra, no similar artifacts were unearthed here or anywhere else in the Naco valley. This patterning may indicate that ceramics were fashioned at the same time, but following different procedures, in these adjacent areas.

The largest quantities of ash and sherds are recorded at Las Canoas ([Figure 35](#)). Here, debris deposits as much as 1 m deep underlie most of the central and southern parts of the center.

Structures dating to late in Las Canoas' occupation were raised atop these deep middens, with most of them, as well as a few smaller buildings, filled with ash, sherds, and other trash, organic and inorganic. The largest building at Site 598 was also filled with ash, sherds, and other midden material. It appears that the flat terrain currently characterizing Las Canoas is largely the result of trash disposal which filled in and leveled an earlier north-to-south descent. Based on the prevalence of distinctive high-necked, red-painted (as much as 35% of some sub-assemblages), unslipped jars in the Las Canoas assemblage (Figures 36a through Figure 36l, shown below), it appears that these were the primary types manufactured here. Sherds from this sort of vessel are so common in Late Classic Naco assemblages that we had assumed they were made in that valley. Comparable vessels are recovered in smaller numbers at Late Classic El Coyote and rural sites along the middle Chamelecon and the Rio Cacaupala.

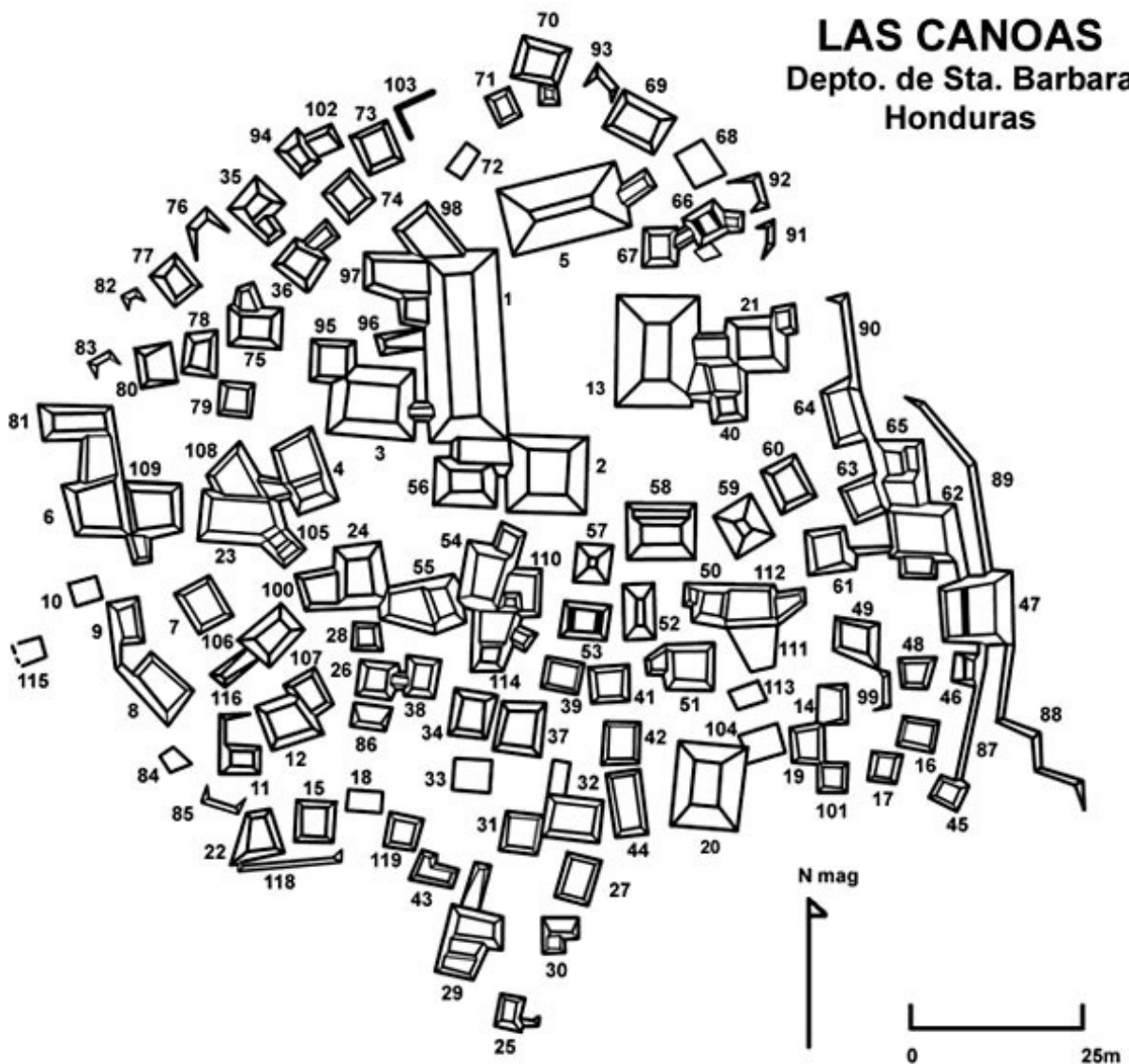

Figure 35. Las Canoas Site Map.



Figure 36a. Examples of red-on-natural ceramics made at Canoas: Monte Grande red-on-natural with typical bird design.



Figure 36b. Monte Grande with shoulder stripes.



Figure 36c. Canoas red-on-natural with striped design, lower section.

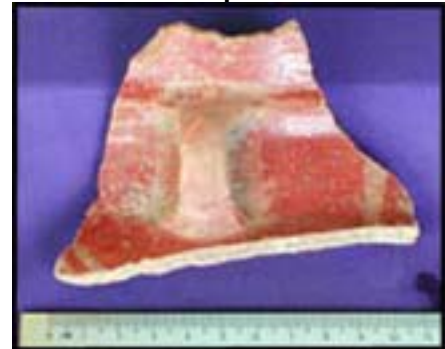

Figure 36d. Canoas neck band and band-to-shoulder handle.



Figure 36e. Canoas neck-shoulder with neck band and cross-hatch design.

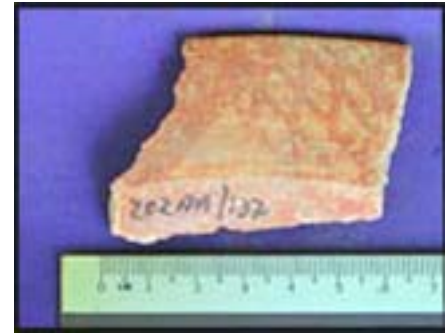

Figure 36f. Jocomico upper rim surface with cross-hatch design.



Figure 36g. Maroncho: white-washed variety showing incision and raised neck band.



Figure 36h. Cuchillo incised neck and shoulder with raised neck band.



figure 36i. Cuchillo incised upper rim and neck interior showing firing errors—bubbling and small spalls.



Figure 36j. Jocomico incised neck and shoulder interior.



Figure 36k. Jocomico incised neck and shoulder exterior.

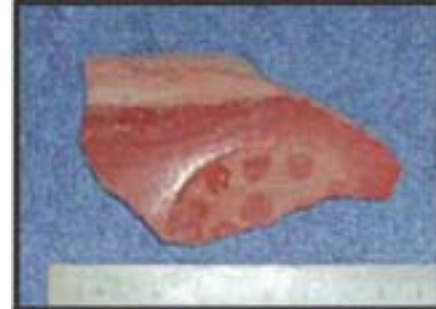

Figure 36l. Impressed medallion on Cuchillo incised.

The depth—up to 2 m below the current ground surface—and spatial extent of trash deposits at Las Canoas strongly suggest that large numbers of pots were fashioned at the center over the course of its two centuries of occupation, possibly by at least a few full-time specialists. While some of the output was locally consumed, a considerable proportion was apparently destined for export to both Naco and the lower Cacaúlapa valleys.

Las Canoas is well situated to serve as the center of a ceramic industry. Extending out for roughly 500 m to the north, south, and west of the settlement are extensive, easily accessible clay deposits. These layers could have fueled the Las Canoas workshops for many years. The reddish-brown clay common to the area has two layers, an upper one with few inclusions, and a lower zone with large quantities of white particles. In the center of Canoas, the upper layer appears to have been removed early in the Late Classic: the site's monumental structures are set on and into the lower, coarser layer. On the east and south margins of the site, cultural materials are found as deep as 2 m below the contemporary ground surface and final phase construction. These deep deposits appear to be filled-in borrow pits. Borrow pits in the adjacent open areas are less obvious, but to the west there are at least a dozen surface-visible depressions. Test excavations in two do support a tentative identification of borrow pit. Preliminary analysis of soils levels revealed in a test pitting program to the south of Canoas also indicates clay removal there, although it may have been more a stripping operation than pit digging.

It is currently not possible to provide reliable estimates of the number of used and worked sherds in the assemblages of any excavated site in the research area. These artifacts are usually only identified during the course of detailed analyses of pottery from specific collection units and not enough of them have been studied to date to serve as a basis for inferring the distribution, scale, and intensity of production. Potstands, on the other hand, are sufficiently distinctive to be recognized

during the initial sorting stage. We can, therefore, use preliminary data on potstand distributions to infer where pottery was being produced.

More than 1,000 potstands were found in Late Classic deposits at Las Canoas. This concentration supports other evidence for large-scale ceramic manufacture at the site. Interestingly, potstands were also found in much smaller numbers at six rural settlements: Site 607 (n=22); Site 599 (n=13); Site 598 (n=3; excavations in 2005 produced more, including two in situ inside a residential building); Site 602 (n=1); Site 120 (n=10); and Site 161 (n=8). The first four settlements are in the Chamelecon drainage within 3 km of Las Canoas. Sites 120 and 161, as noted earlier, lie on the west bank of the Rio Cacaupala up to 300 m south of its junction with the Chamelecon. It appears, therefore, that a wide range of people distributed throughout both drainages was engaged in fashioning ceramic vessels using at least some of the same techniques. One of the salient exceptions to this pattern is El Coyote where extensive excavations from 1999-2004 recovered only one potstand. It may be that occupants of this regional center, unlike Las Canoas or La Sierra in the Naco valley, were consumers of pottery vessels made elsewhere. Some of these containers likely were provided by Las Canoas' workshops while others could have derived from myriad small-scale producers.

Judging the scale and intensity of rural ceramic manufacture is difficult at this point. The absence of large trash deposits associated with the industry outside of Las Canoas implies that production throughout the hinterland generated limited quantities of vessels and was probably conducted by part-time specialists. There is also no sign that rural artisans were fashioning large numbers of specific vessels, like the red-on-natural jars so prevalent at Las Canoas. More likely, craft workers outside Las Canoas produced a wide range of utilitarian wares for their own use, exchange with other households, and, possibly in the lower Cacaupala valley, as tribute paid to rulers at El Coyote.



Figure 37a. Mold from Las Canoas: Figurine/Ocarina mold from 2002 season.



Figure 37b. Mold from Las Canoas: Figurine/Ocarina mold from 2002 season.



Figure 37c. Mold from Las Canoas: Figurine/Ocarina mold from 2002 season.



Figure 37d. Mold for modeled incensario face, 2004 season.

Thirteen molds for making the figurative portions of figurines, ocarinas, and whistles, and a probable mold for faces on incensarios, were also recovered from Late Classic contexts at Las Canoas during the 2002 and 2004 field seasons ([Figures 37a](#) through [Figure 37d](#), shown above). An additional two molds were also unearthed, one at Site 599 and the other at Site 120. As in Naco, figurines, ocarinas, and whistles themselves, likely used in household rituals, are widespread, coming from every investigated Late Classic site. It may be that Las Canoas' artisans enjoyed a local edge in fashioning these generally needed items, though they did not monopolize their production. Figurine manufacture may also have not been a purely local concern. La Sierra, with its far greater number of molds as well as fine-grained clays more suitable than those of other sites for showing the details of molded items, may well have been a major provider of ceramic effigies over a wide area that stretched to include the middle Chamelecon and lower Cacaupala valleys. Artisans at Las Canoas, Sites 598, and 120, therefore, could have been secondary and tertiary producers, respectively, their output geared to meeting parochial demand within a broader network dominated by La Sierra. Chemical and mineralogical tests of figurine pastes from various sites, matched against local clay sources, are needed to evaluate this proposition.

There is no evidence of pottery or figurine production in the lower Cacaupala and middle Chamelecon valleys which dates to the Early Postclassic. Figurines largely disappear from assemblages pertaining to the latter period. Pottery is certainly being made during the Early Postclassic, though the absence of potstands suggests a marked change in the manufacturing process.

Obsidian Production

The middle Chamelecon has several sources of perlite, that is, a form of obsidian found in small nodules in volcanic tuff. These nodules are very seldom large enough for blade production, but were instead made into expedient flakes that were used in a variety of ways. Such expedient tools are common at all investigated sites. Obsidian blades are also ubiquitous in the lithic assemblages of all Late Classic and Early Postclassic sites within the research zone. Nevertheless, prior to late in the 2004 field season, we had found few of the cores from which they were removed. Excavations at Site 162 in the Cacaupala drainage, however, dramatically changed this picture.

Site 162 initially drew our attention because of its relatively isolated location. Set on a very narrow area of level terrain within steeply sloping hills, devoid of any nearby perennial water sources, and without ready access to arable land, Site 162 seemed admirably located to make meeting the needs of daily life as difficult for its inhabitants as possible. We, therefore, presumed that Site 162 was a special-purpose site, possibly occupied only intermittently during the year.



Figure 38. Site PVC 162, Overview of recovered obsidian cores.

Excavations designed to test this proposition successfully undermined our interpretation. Not only was the settlement apparently used year-round, but it yielded 82 polyhedral obsidian cores and core fragments, 24 from one small room alone in the chief residence, Str. 162-2 ([Figure 38](#)). Based on the analyses of William McFarlane, production debris recovered from the site strongly points to the knapping of blades here during the Late Classic ([Figures 39a](#) through [Figure 39h](#)).



Figure 39a. Initial platform preparation flake, obverse.



Figure 39b. Initial platform preparation flake, reverse.



Figure 39c. Site PVC 162, Obsidian Core Platform Details, rejuvenated.



Figure 39d. Site PVC 162, Obsidian Core Platform Details, scarred.



Figure 39e. Site PVC 162, Obsidian Core Platform Details, ground.



Figure 39f. Site PVC 162, Obsidian Core Platform Details, poorly organized core.



Figure 39g. Site PVC 162, Obsidian Core Details, core with large inclusion.



Figure 39h. Site PVC 162, Obsidian Core Details, step fracture.

It currently appears, therefore, that blade production in the Late Classic lower Cacaupala valley was highly centralized, possibly monopolized by a small household residing above, but not in, El Coyote. It is unclear whether Las Canoas' residents also obtained blades from those living at Site 162. One polyhedral core, reworked into a tool, and a small amount of obsidian production debris have been recovered from Las Canoas. While this pattern indicates that blades were imported into, and not made at, the center, the source of these implements could be the Naco valley where large blade workshops have been identified. In addition, the point of origin for a remarkable obsidian biface found at Site 120 ([Figure 40a](#), shown below) is unclear. Current evidence does not suggest that it was made locally, but neither is a local manufacturing precluded.



Figure 40a. Site PVC 120, Obsidian biface.

Who the denizens of Site 162 were, how they obtained their cores, and how much control they had over the distribution of their output remain unknown. The physical isolation of Site 162 may imply some social distance between its residents and those of the regional capital. At the same time, the lack of water sources and arable land close by suggest that these hilltop denizens relied on others for basic resources essential to their survival. This small enclave, therefore, occupied a distinctive place in Late Classic lower Cacaupala society and may have been linked to that society through ties of mutual dependence. Whether these processes contributed to the construction of the Late Classic political hierarchy, however, is unknown.

There is still no evidence of blade production anywhere in the lower Cacaupala or middle Chamelecon valleys during the Early Postclassic. In fact, about a third of the El Coyote obsidian assemblage during this period is comprised of green obsidian blades from the Pachuca source, blades that were imported ready-made; in addition, one Pachuca blade was found at Site 598 during work in 2005. It is very likely that blades from other sources, including Ucarero in western México and Ixtepeque in eastern Guatemala, also arrived in the valley in completed form. The primary Early Postclassic lithic industry consisted of producing bifacial tools using local chert. A large workshop devoted to this task was uncovered at El Coyote where over 700 pounds of chert tools and debris were recovered from approximately 4 m³; [Figure 40b](#), below, illustrates such a biface, found at Site 120, but not definitively made at El Coyote. At present, however, it appears that whereas chert tool manufacture may have been localized at the lower Cacaupala's regional center, obsidian blade production was occurring outside the research zone entirely.



Figure 40b. Site PVC 120, Chert biface.

Copper Processing

Recovery of copper-bearing slag from the far southeastern margins of El Coyote at the end of the 2002 field season suggested that this metal was being processed here ([Figure 41](#) and [Figure 42](#)). Identification of easily accessible copper sources, within 6 km east and southwest of the capital, supported the feasibility of copper working at El Coyote. As of the start of the 2004 field season, however, this copper workshop was only tentatively identified, poorly understood, and undated.

Excavations conducted during 2004, in close consultation with Dr. Aaron Shugar of the Smithsonian Institution and Buffalo State University, have greatly clarified this picture. Testing of eight activity areas in the vicinity of the original slag find-spots have revealed: an area where copper-bearing rocks were collected and initially broken up; an in situ ceramic furnace where the resulting ore nuggets were heated; a stone surface where post-heating slag was crushed and the copper removed; and two piles where broken furnaces and slag were dumped. There is little doubt that copper processing was being carried out at El Coyote on a fairly large scale. The dates for this industry, however, remain to be determined.

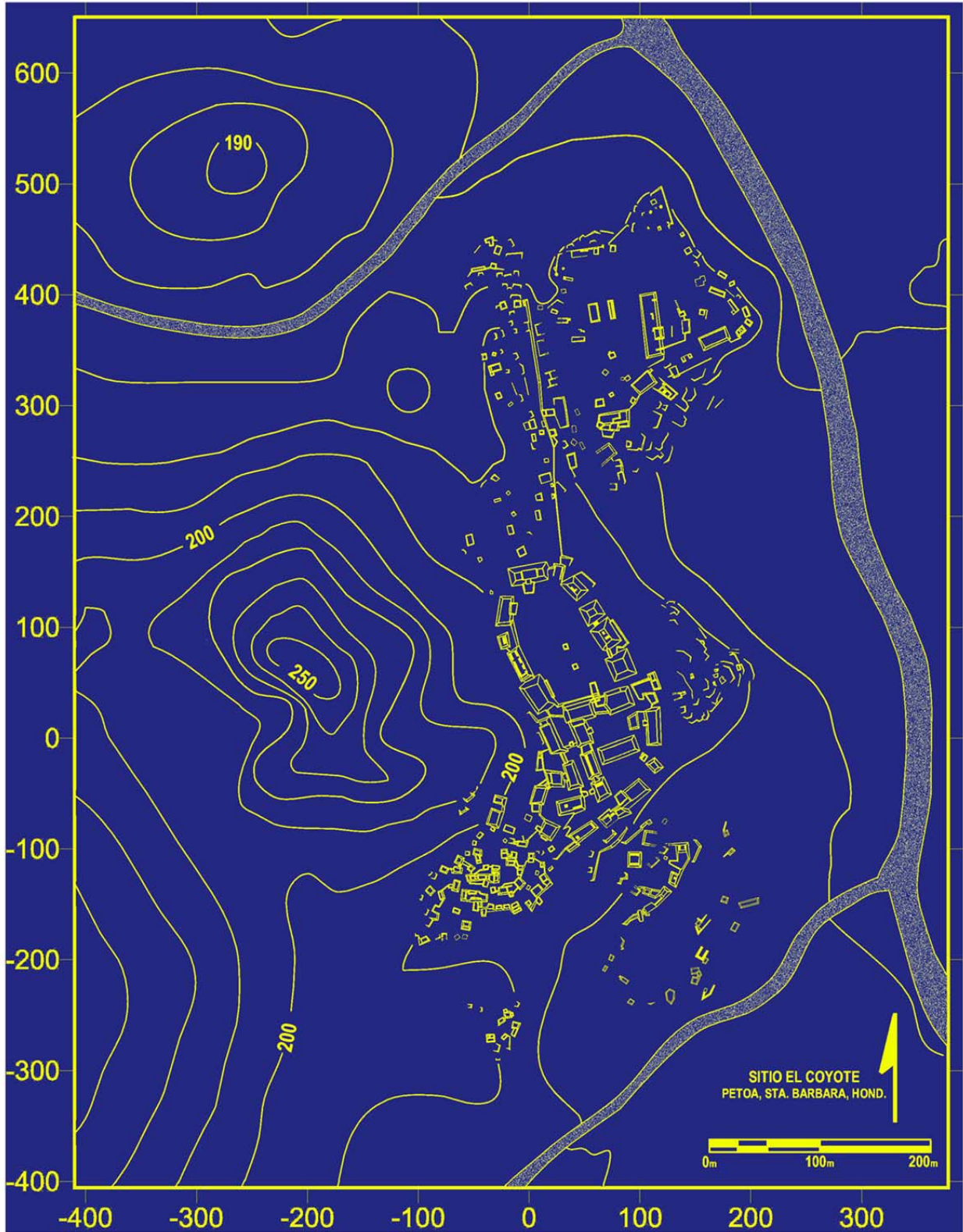

Figure 41. El Coyote Site Map.

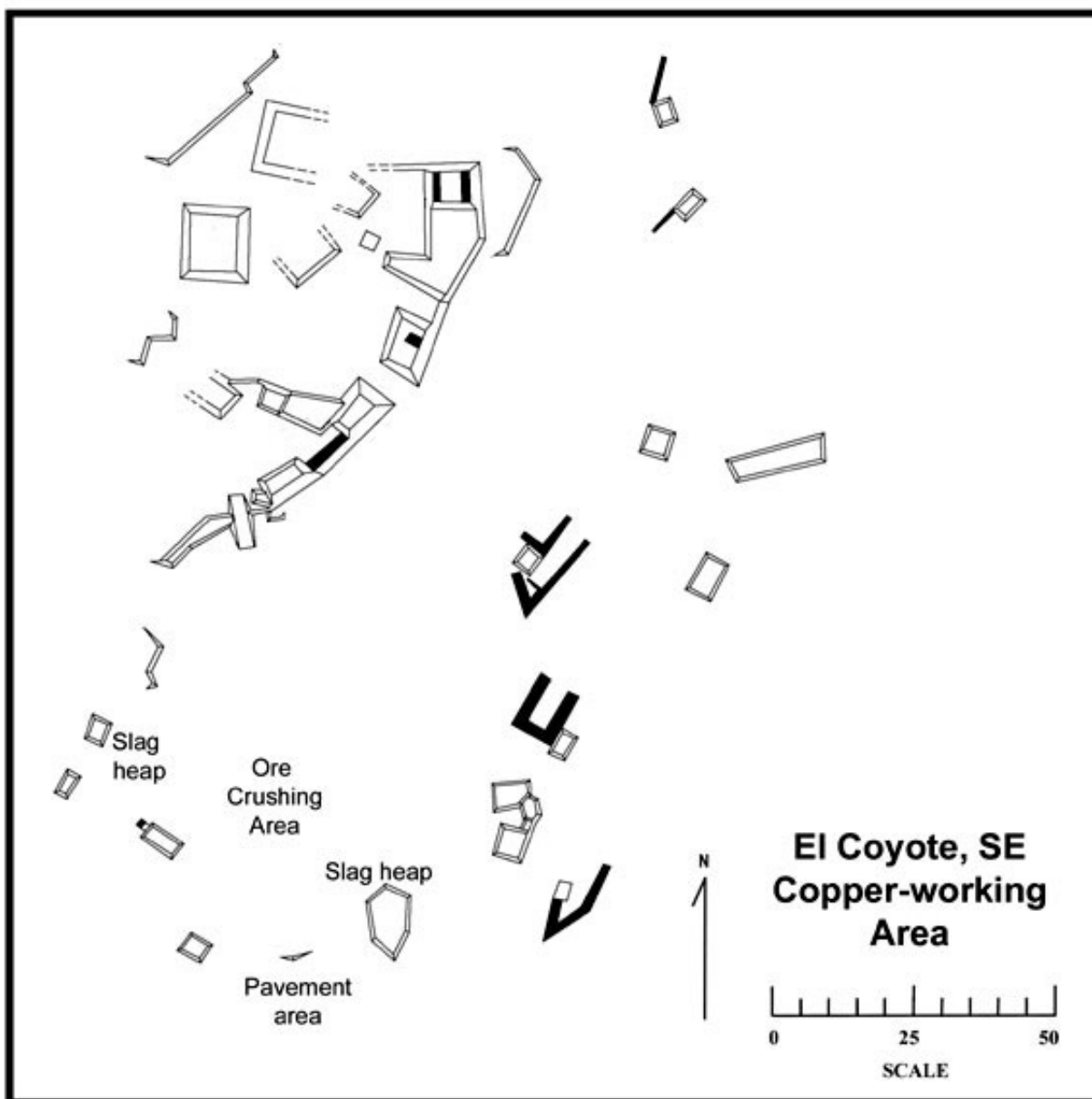

Figure 42. El Coyote, Detail, Copper-working area.

The mound of copper-bearing rocks stockpiled for processing is associated with three large stones, one of which bears a basin-shaped depression resulting from repeated pounding and grinding ([Figure 43a](#), [Figures 43b](#) and [Figure 43c](#), shown below). The goal of this stage seems to have been to separate most of the copper from the surrounding matrix in which it was embedded. A crudely fashioned stone mallet was found in another excavation unit; it likely was used for ore crushing.



Figure 43a. Ore Crushing area: rock with depressions, ore to left of rock, maul left of trowel.



Figure 43b. Another maul in situ.



Figure 43c. Rectangular maul in situ.

Subsequently, these copper-rich fragments were taken to furnaces no more than 20 m to the south where they were heated to their melting point. The one such oven found in place, off the south edge of a 0.12 m high stone platform, is a square adobe construction ([Figure 44a](#); [Figure 44b](#) and [Figure 44c](#), shown below). The south side, that facing away from the platform, was broken off at the end of the heating cycle, allowing the molten material to flow out and pool in a prepared depression within the ancient ground surface. A similar platform, with furnace fragments in its vicinity, lies 7 m west-northwest of this construction. There may, therefore, have been several heating facilities in operation at any one time in the workshop's history.



Figure 44a. Furnace for copper smelting: El Coyote, Str. 372, Furnace in situ, north to right.

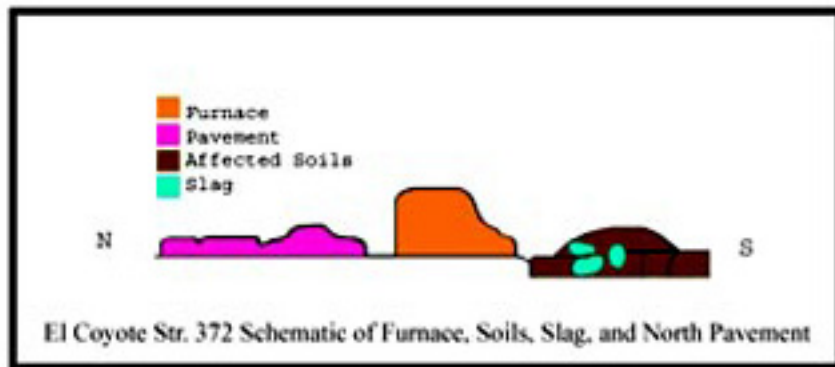

Figure 44b. Furnace for copper smelting: El Coyote, Str. 372, Furnace Schematic (Drawing courtesy of Laura Richardson).



Figure 44c. Furnace from discarded furnace deposit showing exterior corner and slag on interior.

A stone pavement was found 3.6 m south of the in situ furnace ([Figure 45a](#), [Figure 45b](#), and [Figure 45c](#), shown below). This floor, composed mostly of white limestone slabs, is partially ringed by vertically-set stones. Directly overlying the surface is a 0.05 m thick level of crushed ore associated with a stone hammer left lying in the northeast corner of the feature. At least two of the stones comprising the floor also bear marks of repeated pounding. It appears, therefore, that this

construction was where the slag produced in the nearby furnace was crushed in order to separate out pure fragments of copper suitable for casting.



Figure 45a. El Coyote, Pavement in copper processing area: Overview, pavement (left) and in situ furnace (right).



Figure 45b. El Coyote, Pavement in copper processing area: Close-up, pavement, showing use of vertical edging stones and placement of columnar basalt.



Figure 45c. El Coyote, Pavement in copper processing area: Detail, pavement stone with depression from crushing slag.

As Ellen Bell initially noted, the white stones of the floor would have made an excellent background against which even small fragments of copper could have been seen. Aaron Shugar, in conversations with whom we arrived at these interpretations, suggests that water from the nearby Rio Cacaupala or Quebrada Seca may have been channeled across the pavement to help remove detritus and isolate copper pieces.

Furnaces (*hornos*) were apparently used only once, their remnants being dumped into heaps located west and east of the firing spot. An estimated ton of slag ([Figures 46a](#) and [Figure 46b](#), shown below) and broken furnaces was recovered in the course of excavating the larger of these disposal sites, which covers 5.3×7.2 m (38 m^2) and averages 0.45 m thick. Such quantities of debris imply a substantial production scale. Given the complexity of copper working, it seems likely that at least those responsible for firing and casting were full-time specialists.



Figure 46a. Slag from copper smelting: large piece of slag.

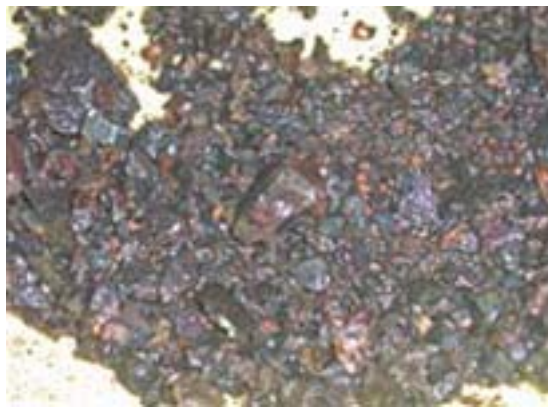

Figure 46b. Slag from copper smelting: crushed slag showing small copper prills.

When these activities were carried out remains uncertain. Both Early Postclassic and Historic period diagnostics were recovered from the workshop and its environs. The retrieval of small fragments of copper ore from Early Postclassic contexts in southeastern El Coyote favors a pre-hispanic date for at least some of the copper working pursued at the center. In addition, crushed copper ore was found on the summits of several buildings in the SE portion of the site, and river cobbles fused together by slag or vitrified clay from *hormos* were used in wall construction. Still, there is no denying the possibility that some, if not most, of the evidence uncovered this season dates to the Historic period. More carbon-14 dating of samples embedded in the slag and directly associated with the firing facility will help to address this central issue. Results from materials examined to date, in experimental attempts to date the slag directly, have been equivocal, spanning pre- and post-columbian eras.

There is no sign of copper working at any rural site. Similarly, copper artifacts have not been recovered outside El Coyote where one small prill was found in the center's Northeast complex.

We must note, however, that if the copper working at El Coyote does not date to the Postclassic, we are left with a major question: what did the inhabitants of El Coyote have to trade for the large quantities of Pachuca obsidian and Plumbate pottery found at the site? Pachuca blades make up at least 40% of the obsidian blade total there, and Plumbate, though a small percentage (about 1-2%)

of the overall assemblage, is much more common than in neighboring regions. For example, in the Naco valley, two or three Pachuca blades were recorded in a total of ca. 50,000 analyzed lithics, and a similar number of Plumbate sherds was found in an analyzed total of just over 850,000 pieces of pottery. El Coyote is an unlikely end point for Pachuca and Plumbate trade, unless the residents produced a valuable, low-bulk commodity. If not copper, what?

Trade

The most obvious signs of long distance trade are the obsidian cores, as well as the Pachuca and other Central Mexican obsidian blades and the Plumbate pottery found in Early Postclassic contexts. Again, what moved out from the study area into wider trade networks remains unknown. There are small quantities of imported ceramics, particularly Ulua polychromes ([Figure 47b](#)), whose origin point is unclear: our pieces are so small, and generally so eroded, that current sorting schemes based on design configurations cannot be utilized to determine loci of manufacture. In Late and Terminal Classic contexts, we see a very few fine-paste materials similar to those from the Lower Motagua Valley and/or Quiriguá, and possibly like Sula Valley materials as well, though it should be noted that Naco Valley potters made fine-paste ceramics virtually identical macroscopically to Sula Valley products. There are also a few sherds of carved wares in Maya styles which may hail from the La Entrada region ([Figure 47a](#)); they do not appear to be locally made. Luxury goods other than pottery are even more uncommon, although the occasional surprise does turn up, such as the greenstone, possibly jade, bead and the jade earflare illustrated in [Figure 47c](#) and [Figure 47d](#).



Figure 47a. Examples of items imported in the Cacaulapa and Middle Chamelecon Region: Carved Copanec-like vessel.



Figure 47b. Examples of items imported in the Cacaupala and Middle Chamelecon Region: Ulua polychrome.



Figure 47c. Examples of items imported in the Cacaupala and Middle Chamelecon Region: Greenstone bead.



Figure 47d. Examples of items imported in the Cacaupala and Middle Chamelecon Region: Greenstone, possibly jade, earflare.

Summary

Preclassic and Early Classic

The only part of the Preclassic which can be seen along the middle Chamelecon and Cacaupala drainages is the end of the Middle Preclassic. Dates for this and other time periods are seen in Table 1:

Table 1. Radiocarbon Dates, Middle Chamelecon Sites

Sample	Measured C ¹⁴ Age	Conventional C ¹⁴ Age	Calibrated 2 Sigma C ¹⁴ Age
120K/038	2650±70 BP	2630±70 BP	910-760 B.C., and 640-560 B.C.
120D/018	2440±40 BP	2340±40 BP	770-400 B.C.
120L/024	2210±70 BP	2180±70 BP	390-40 B.C.
202DA/023	1490±40 BP	1460±40 BP	A.D. 540-660
202DU/032	1410±40 BP	1370±40 BP	A.D. 620-700
*599B/037	1310±110 BP	1310±110 BP	A.D. 540-980
120V/005	1210±40 BP	1210±40 BP	A.D. 700-900

*Site 599 is a small (4-6 structures) site with all but two buildings damaged by plowing, lying about 120 m SW of Las Canoas; the undamaged platforms were cleared in 2004.

Late Middle Preclassic materials have also been recovered at several locales within El Coyote, as have Late Preclassic materials. During work in the summer of 2006, an extensive Middle Preclassic occupation associated with a large earthen mound was found on a vega on the south bank of the Chamelecon, roughly across from Site 598. The structure is similar to those at Site 120, and the ceramics are indistinguishable from those at Site 120. Rural sites, however, have shown no clear Late Preclassic levels or materials, nor has the Early Classic been identified at any of these sites. The Early Classic is inferred to have existed at El Coyote on the basis of Chilanga Usulután and similar materials recovered there. The very few resist-decorated, red-painted items at Las Canoas hint at a slight Early Classic occupation there as well.

Late Classic

During this interval some craft production was apparently pursued in centers, such as Las Canoas, as well as in rural hamlets scattered throughout adjoining portions of the Chamelecon and lower Cacaupala drainages. It appears that pottery manufacture was conducted on a much larger scale at Las Canoas than at any other known site outside La Sierra in the Naco valley. Such heightened involvement in this particular craft may relate to the role Las Canoas' potters played in providing a subset of widely used, red-on-natural jars to consumers in both the Naco and lower Cacaupala valleys. Nevertheless, denizens of most rural sites seem to have made at least some of their own ceramic containers, with techniques roughly analogous to those inferred for Las Canoas: using potstands to shape ceramics and support them while being fired. Despite making and distributing red-on-natural pottery in substantial quantities, the residents of Las Canoas apparently displayed few signs of wealth such as notable quantities of imported ceramics or stone jewelry; residents of smaller, rural loci have even fewer markers of such prosperity.

Obsidian blade production shows an unexpected pattern. Pursued at a relatively remote site overlooking, but not in, El Coyote, this activity seems to have been exclusively in the hands of a rural household. As far as we can tell at present, all Late Classic residents of the lower Cacaupala drainage depended on these artisans for an implement that was widely used and, presumably, highly valued. It is not clear, however, what benefits this monopoly yielded to those who so effectively guarded it. Their structures do not bespeak great power nor is their material assemblage replete with valuable commodities, such as imported polychromes. How obsidian blade production fit into the Late Classic lower Cacaupala political economy is still unclear.

What is becoming increasingly obvious, however, is that El Coyote's residents were consumers, not manufacturers, of most of the goods they needed. Christian Wells (2003) has recently raised the intriguing suggestion that Late Classic El Coyote elites organized specialized production as part of work-party feasts periodically held at the regional capital. This may well be the case, but such occasional gatherings do not yield the wealth of tools or detritus associated with pottery production or blade knapping now available for other sites in the region, such as Las Canoas and Site 162. It may be that several, intersecting forms of production and distribution coexisted in the study zone during the Late Classic. Manufacturing of some articles at elite-sponsored gatherings at El Coyote might have generated items needed during those feasts. Alternating with these pulses of relatively intense

production was the day-to-day pursuit of craft activities conducted by full- and part-time specialists in both rural hamlets and Las Canoas. Through these differing, but interconnected economic systems, pottery and obsidian blades moved up and down the hierarchy as well as laterally across the drainages.

Early Postclassic

Population seems to decline in the middle Chamelecon drainage at this time. Las Canoas, if still occupied at all, supported a much reduced population and only two of its nearby settlements, Site 601 ca. 150 m to the northwest, and Site 598 further to the southwest along the Chamelecon, were clearly still occupied now. Site 607 shows architectural evidence of Early Postclassic use, but the ceramics are equivocal, as are the ceramics from site 598; Site 601, however, has clear Early Postclassic local ceramics. In the lower Cacaulapa valley, no Early Postclassic components have been identified in excavated rural settlements. El Coyote itself, however, remained a major political and demographic center at this time. Possibly there was less of a population decline in the lower Cacaulapa than a concentration of people at the regional capital.

Evidence for craft production is scarce during this interval at all known sites. El Coyote now seems to have been a center of chert tool manufacture, its artisans producing bifaces that may then have been distributed across the research area. If copper was being processed here during the Early Postclassic, then local artisans were participating in a technology that linked them to distant markets and sources of inspiration. It may have been through these connections that the unusually large numbers of Pachuca obsidian blades recovered from El Coyote arrived at the capital. As intriguing as this possibility is, it remains no more than a hypothesis until issues of chronology are resolved.

It might be that the apparent decline in specialized production is more imagined than real. Clearly, people were still making pottery, though blades were seemingly imported in finished form and not knapped in the lower Cacaulapa and middle Chamelecon drainages. Specialized tools, such as potstands, used in the manufacturing process no longer appear, however. This certainly indicates a change in the manner in which pottery vessels were fashioned. If this shift marks a simplification of the manufacturing process, then it might imply that there were fewer limits to participation in the craft than had been the case during the Late Classic. Literally, everyone now had access to the resources and knowledge needed to fashion pottery containers, this craft changing from a specialized, if widely distributed, pursuit to a daily household chore. This tentative surmise is supported by the decline in both the quality and range of decoration in ceramics from the Late Classic to the Early Postclassic within the research zone.

With the exception of chert-working and, possibly, copper processing, specialized production may have waned in political and economic significance during the Early Postclassic. This development possibly signified an increase in household economic autonomy vis a vis the Late Classic and simpler networks linking households within any one polity and the members of different realms. There is no evidence, for example now, of a site like Las Canoas whose artisans fashioned goods for distribution to the residents of several distinct, independent, and sizable political units.

Further research may well alter these interpretations. What is unlikely to change is the emerging picture of just how complex the political economies of even the smallest realms can be. As if this were not enough, analyses completed to date suggest that these systems were moving targets, their components changing through time as well as across space. Craft production is but one variably

important part of these ancient political and economic relations, one window through which we can view their operation. There is much more to do before we can capture this messy, shifting reality, the vague outlines of which are just now coming to light.

Acknowledgements

We wish to thank FAMSI for funding the work discussed in this report. Other excavation and analysis were supported by the Kenyon-Honduras Program, an off-campus study program that we direct in Honduras for Kenyon College, and an NSF Research Experiences for Undergraduates grant that partially funded participants. We thank the students of the 2004 season for their attentive work, as well as our excellent staff—Co-Director Ellen Bell, and Senior Staff Charlie Webber, Leigh Anne Ellison, and Anna Novotny—volunteers, and our archaeometallurgy consultant, Dr. Aaron Shugar. The residents of our Honduran home towns, Pueblo Nuevo and Petoa, were welcoming and helpful, as they have been since the inception of our work in the area during the summer of 1999. Field workers from both towns as well as other smaller locales in the area did a superb job of excavating and dealing with the peculiarities of the foreigners, oftentimes speaking broken Spanish, in their midst. As in previous seasons, IHAH provided supervision and assistance of various sorts; we thank in particular the regional supervisor Juan Alberto (Beto) Duron, and the field technician assigned to us, David Aguila. Any errors of omission or commission in this report are solely due to the authors' slips of the mind.

List of Figures

- [Figure 1.](#) Map of Southeastern Mesoamerica.
- [Figure 2.](#) Sites mentioned in the text.
- [Figure 3.](#) Site PVN 202, Las Canoas Site Map (PVN: Proyecto Valle de Naco).
- [Figure 4.](#) Site PVN 607 Site Map.
- [Figure 5.](#) Site PVN 607 Excavation Plan.
- [Figure 6.](#) Site PVN 607, Structure 1, Overview.
- [Figure 7.](#) Site PVN 607, Str. 2, Overview, taken from the south.
- [Figure 8a.](#) Site PVN 607, Str. 3, Overview, Northeast corner in foreground.
- [Figure 8b.](#) Site PVN 607, Str. 3, Detail, West basal wall, northwest corner in foreground.
- [Figure 9a.](#) Site PVN 607, Str. 4, South end, viewed from the east.
- [Figure 9b.](#) Site PVN 607, Str. 4, Northwest corner showing terracing.
- [Figure 10.](#) Site PVN 598 Site Map.
- [Figure 11.](#) Site PVN 598 Excavation Plan.
- [Figure 12a.](#) Site PVN 598, Str. 1, Viewed from the east, showing terracing.
- [Figure 12b.](#) Site PVN 598, Str. 1, Viewed from the west, showing summit room and terracing.

[Figure 13a.](#) Site PVN 598, Str. 2, Detail, Stairs, south side.

[Figure 13b.](#) Site PVN 598, Str. 2, Detail, North summit wall.

[Figure 13c.](#) Site PVN 598, Str. 2, Detail, North basal facing.

[Figure 14.](#) Site PVC 120 Site Map, Structures only (PVC: Proyecto Valle de Cacaulapa).

[Figure 15.](#) Site PVC 120 Contour Map.

[Figure 16.](#) Site PVC 120 Excavation Plan, Central Cluster.

[Figure 17.](#) Site PVC 120 Excavation Plan, Western Site Area.

[Figure 18.](#) Site PVC 120, Str. 2, Northwest corner and west side, showing casual Late Classic construction that overlies Preclassic deposits.

[Figure 19a.](#) Site PVC 120, Str. 4, Viewed from the south.

[Figure 19b.](#) Site PVC 120, Str. 4, Viewed from the east showing summit room.

[Figure 20.](#) Site PVC 120, Overview of Strs. 4 and 5, taken from the west.

[Figure 21.](#) Site PVC 120, Str. 6, Preclassic surface.

[Figure 22.](#) Site PVC 120, Str. 7, Section, west side showing Preclassic earthen construction.

[Figure 23.](#) Site PVC 120, Str. 18, Showing casually-made Late Classic construction.

[Figure 24.](#) Site PVC 161 Site Map.

[Figure 25.](#) Site PVC 161 Excavation Plan.

[Figure 26.](#) Site PVC 161, Str. 2, Terraces.

[Figure 27.](#) Valley view from Site PVC 162.

[Figure 28a.](#) Site PVC 162 Site Map, Contours.

[Figure 28b.](#) Site PVC 162 Site Map, Structures.

[Figure 29.](#) Site PVC 162, Excavation Plan.

[Figure 30.](#) Site PVC 162, Str. 1, Overview.

[Figure 31.](#) Site PVC 162, Str. 2, Overview, taken from southwest.

[Figure 32.](#) Site PVC 162, Str. 2, Detail, East room with plaster floor.

[Figure 33a.](#) Assortment of diamond-shaped tools made from potsherds.

[Figure 33b.](#) Flat edge, possibly ground.

[Figure 33c.](#) Wear on corner of rectangular tool.

[Figure 33d.](#) Worn point, diamond-shaped tool.

[Figure 33e.](#) Wear on large spall.

[Figure 33f.](#) Opportunistic tool from PVN 607.

[Figure 33g.](#) Close-up, wear on PVN 607 opportunistic tool.

[Figure 34a.](#) Purpose-made potstand, PVC 120.

[Figure 34b](#). Potstand made from recycled flared-neck jar, showing discoloration due to reheating and baked-on clay, PVC 161.

[Figure 34c](#). Purpose-made potstand showing slight discoloration from reheating, PVN 607.

[Figure 34d](#). Purpose-made potstand showing discoloration from reheating, PVN 607.

[Figure 34e](#). Purpose-made potstand, extensively discolored, with baked-on clay, PVN 202 (Las Canoas).

[Figure 34f](#). Extensively discolored potstand with baked-on clay, made on recycled jar, PVN 202 (Las Canoas).

[Figure 35](#). Las Canoas Site Map.

[Figure 36a](#). Examples of red-on-natural ceramics made at Canoas: Monte Grande red-on-natural with typical bird design.

[Figure 36b](#). Monte Grande with shoulder stripes.

[Figure 36c](#). Canoas red-on-natural with striped design, lower section.

[Figure 36d](#). Canoas neck band and band-to-shoulder handle.

[Figure 36e](#). Canoas neck-shoulder with neck band and cross-hatch design.

[Figure 36f](#). Jocomico upper rim surface with cross-hatch design.

[Figure 36g](#). Maroncho: white-washed variety showing incision and raised neck band.

[Figure 36h](#). Cuchillo incised neck and shoulder with raised neck band.

[Figure 36i](#). Cuchillo incised upper rim and neck interior showing firing errors—bubbling and small spalls.

[Figure 36j](#). Jocomico incised neck and shoulder interior.

[Figure 36k](#). Jocomico incised neck and shoulder exterior.

[Figure 36l](#). Impressed medallion on Cuchillo incised.

[Figure 37a](#). Mold from Las Canoas: Figurine/Ocarina mold from 2002 season.

[Figure 37b](#). Mold from Las Canoas: Figurine/Ocarina mold from 2002 season.

[Figure 37c](#). Mold from Las Canoas: Figurine/Ocarina mold from 2002 season.

[Figure 37d](#). Mold for modeled incensario face, 2004 season.

[Figure 38](#). Site PVC 162, Overview of recovered obsidian cores.

[Figure 39a](#). Initial platform preparation flake, obverse.

[Figure 39b](#). Initial platform preparation flake, reverse.

[Figure 39c](#). Site PVC 162, Obsidian Core Platform Details, rejuvenated.

[Figure 39d](#). Site PVC 162, Obsidian Core Platform Details, scarred.

[Figure 39e](#). Site PVC 162, Obsidian Core Platform Details, ground.

[Figure 39f](#). Site PVC 162, Obsidian Core Details, poorly organized core.

[Figure 39g](#). Site PVC 162, Obsidian Core Details, core with large inclusion.

[Figure 39h](#). Site PVC 162, Obsidian Core Details, step fracture.

[Figure 40a](#). Site PVC 120, Obsidian biface.

[Figure 40b](#). Site PVC 120, Chert biface.

[Figure 41](#). El Coyote Site Map.

[Figure 42](#). El Coyote, Detail, Copper-working area.

[Figure 43a](#). Ore Crushing area: rock with depressions, ore to left of rock, maul left of trowel.

[Figure 43b](#). Another maul in situ.

[Figure 43c](#). Rectangular maul in situ.

[Figure 44a](#). Furnace for copper smelting: El Coyote, Str. 372, Furnace in situ, north to right.

[Figure 44b](#). Furnace for copper smelting: El Coyote, Str. 372, Furnace Schematic (Drawing courtesy of Laura Richardson).

[Figure 44c](#). Furnace from discarded furnace deposit showing exterior corner and slag on interior.

[Figure 45a](#). El Coyote, Pavement in copper processing area: Overview, pavement (left) and in situ furnace (right).

[Figure 45b](#). El Coyote, Pavement in copper processing area: Close-up, pavement, showing use of vertical edging stones and placement of columnar basalt.

[Figure 45c](#). El Coyote, Pavement in copper processing area: Detail, pavement stone with depression from crushing slag.

[Figure 46a](#). Slag from copper smelting: large piece of slag.

[Figure 46b](#). Slag from copper smelting: crushed slag showing small copper prills.

[Figure 47a](#). Examples of items imported in the Cacaulapa and Middle Chamelecon Region: Carved Copanec-like vessel.

[Figure 47b](#). Examples of items imported in the Cacaulapa and Middle Chamelecon Region: Ulua polychrome.

[Figure 47c](#). Examples of items imported in the Cacaulapa and Middle Chamelecon Region: Greenstone bead.

[Figure 47d](#). Examples of items imported in the Cacaulapa and Middle Chamelecon Region: Greenstone, possibly jade, earflare.

Sources Cited

Brumfiel, E., and T. Earle

- 1987 "Specialization, Exchange, and Complex Societies: An Introduction."
In *Specialization, Exchange, and Complex Societies*. E. Brumfiel and T. Earle,
eds. pp. 1-9. Cambridge: Cambridge University Press.

Costin, C.

- 1991 "Craft Specialization: Issues in Defining, Documenting, and Explaining the
Organization of Production." In *Archaeological Method and Theory*, Volume 3.
M. Schiffer ed., pp. 1-56. Tucson: University of Arizona Press.

Ekholm, K.

- 1972 *Power and Prestige: The Rise and Fall of the Kongo Kingdom*. Uppsala: SKRIV
Service AB.

Hasemann, G., V. Veliz, and L. Van Gerpen

- 1978 "Informe preliminary Curruste, Fase1. San Pedro Sula, Honduras: Patronato
Pro Curruste." Report submitted to the Instituto Hondureño de Antropología e
Historia.

Hayden, B

- 1995 "Pathways to Power: Principles for Creating Socioeconomic Inequalities."
In *Foundations of Social Inequality*. T.D. Price and G. Feinman eds., pp. 15-86.
NY: Plenum Press.

- 1998 "Practical and Prestige Technologies: The Evolution of Material Systems."
In *Journal of Archaeological Method and Theory* 5:1-55.

Hendon, J.

- 2000 "Excavaciones en el Sitio CR-157 (Cerro Palenque), temporada 2000: Informe
preliminar del Proyecto Arqueológico Cerro Palenque."
<http://www.gettysburg.edu/~jhendon/Webpage/index.html>.

Joyce, R.

- 1988 "The Ulua Valley and the Coastal Maya Lowlands: The View from Cerro
Palenque." In *The Southeast Classic Maya Zone*. E. Boone and G. Willey, eds.,
pp. 269-295. Washington, D.C.: Dumbarton Oaks.

- 1991 *Cerro Palenque: Power and Identity on the Maya Periphery*. Austin: University
of Texas Press.

Lopez Varela, S., P. McAnany, and K. Berry

2001 "Ceramic Technology at Late Classic K'axob, Belize." In *Journal of Field Archaeology* 28:177-191.

Nakamura, S., K. Aoyama, and E. Uratsuji (eds.)

1991 *Investigaciones arqueológicas en la región de La Entrada, departamentos de Copán y Santa Bárbara, Honduras, CA: Primera fase.* San Pedro Sula, Honduras: Instituto Hondureño de Antropología e Historia, Servicios de Voluntarios Japoneses para la Cooperación con el Extranjero.

Robinson, E.

1987 "Sula Valley Regional and Interregional Interaction: A View from the East Side Alluvial Fans." In *Interaction on the Southeast Mesoamerican Frontier: Prehistoric and Historic Honduras and El Salvador.* E. Robinson, ed., pp. 154-195. Oxford: British Archaeological Reports International Series 327.

Pool, C.

1992 "Integrating Ceramic Production and Distribution." In *Ceramic Production and Distribution: An Integrated Approach.* G. Bey III and C. Pool eds., pp. 275-313. Boulder: Westview Press.

Schortman, E.

1993 *Archaeological Investigations in the Lower Motagua Valley, Izabal, Guatemala: A Study in Monumental Site Function and Interaction.* Philadelphia: Quiriguá Reports III, The University Museum, University of Pennsylvania.

Schortman, E. and P. Urban

1994 "Living on the Edge: Core/Periphery Relations in Ancient Southeastern Mesoamerica." In *Current Anthropology* 35:401-430.

Schortman, E., P. Urban, W. Ashmore, and J. Benyo

1986 "Interregional Interaction in the Southeast Maya Periphery: The Santa Bárbara Archaeological Project 1983-1984 Seasons." In *Journal of Field Archaeology* 13:259-272.

Sharer, R.

1990 *Quiriguá: A Classic Maya Center and its Sculpture.* Durham: Carolina Academic Press.

Sheptak, R.

- 1987 "Interaction between Belize and the Ulua Valley." In *Interaction on the Southeast Mesoamerican Frontier: Prehistoric and Historic Honduras and El Salvador*. E. Robinson, ed., pp. 247-266. Oxford: British Archaeological Reports International Series 327.

Tosi, M.

- 1984 "The Notion of Craft Specialization and its Representation in the Archaeological Record of Early States in the Turanian Basin." In *Marxist Perspectives in Archaeology*. M. Spriggs, ed. pp. 22-52. Cambridge: Cambridge University Press.

Urban, P. and E. Schortman

- 1988 "The Southeastern Zone Viewed from the East: Lower Motagua-Chamelecon." In *The Southeastern Classic Maya Zone*. E. Boone and G. Willey eds., pp. 223-267. Washington, D.C.: Dumbarton Oaks.

Urban, P., M. Ausec, and E.C. Wells

- 1996 "The Fires Within and the Fires Without: Evidence for Ceramic Production Facilities at the Late Classic Site of La Sierra, Northwestern Honduras, and in its Environs." In *Prehistory and History of Ceramic Kilns*. P. Rice ed., pp. 173-194. Columbus: American Ceramics Society.

Webster, D., A.-C. Freter, and N. Gonlin

- 2000 *Copán: The Rise and Fall of an Ancient Maya Kingdom*. New York: Harcourt College Publishers.